



TruVision M Series

TruVision IP bullet cameras 4MP, 8MP



OVERVIEW

The TruVision M-series IP bullet cameras leverages the latest H.265+ video compression technology to bring state-of-the-art, high-definition pictures to the mass video surveillance market. With video resolutions from 4 Megapixel to 4K, these IP cameras represent a flexible video surveillance device to meet any need. Equipped with advanced technology and signal processing capability, they effectively capture video under challenging conditions.

The cameras go above and beyond standard motion detection with enhanced alarm capabilities, including cross line detection, intrusion detection and face detection features. With its smart person/vehicle feature the camera can ignore irrelevant motion or VCA events which will automatically lead to less storage consumption and faster retrieval of relevant video events.

TruVision cameras utilise H.265+ and/or H.264 compression technology with triple-streaming capability, making it easy to manage the camera's bandwidth usage. Recording to a local MicroSD card (not included) protects data in the event of network disruptions.

4MP DETAILS





- Maximum Resolution: 4MP (2688 x 1520)
- Person/vehicle classification
- Video intelligence: intrusion detection, cross line detection, face detection
- Up to 40 m IR illumination
- H.265+ compression
- ONVIF Profile G, S, T open standards
- Edge recording up to 256 GB SDHC card

8MP DETAILS

- Maximum Resolution: 8MP/4K (3840 x 2160)
- Motorised zoom lens 2.8 to 12 mm
- Person/vehicle classification
- Video intelligence: intrusion detection, cross line detection, face detection
- Up to 60 m IR illumination
- H.265+ compression
- ONVIF Profile G, S, T open standards
- Edge recording up to 256 GB SDHC card





Technical Specifications

TruVision 4MP, 8MP

		TVGP-M01-0401-BUL-G	TVGP-M01-0402-BUL-G	TVGP-M01-0801-BUL-G	TVGP-M01-0802-BUL-G
					
General	Technology	IP			
	Video standard	NTSC, PAL			
	Image settings	Hallway View, Mirror, ROI (Region Of Interest)			
	Privacy masking	Yes			
	Software compatibility	Milestone XProtect, OnGuard, TruVision Navigator, TVRmobile, Web Browser			
Camera	Sensor size	1/3"		1/2.8"	
	Max. resolution	4 MP		8 MP (4K)	
	Sensor scan	Progressive			
	Sensor type	CMOS			
	Shutter time	1/3 to 1/100,000 s			
Lighting performance	WDR type	True WDR			
	WDR	120 dB			
	Digital noise reduction	3D DNR			
	Day/night	True Day/Night			
	Motorised IR cut filter	Yes			
	Color sensitivity	Colour: 0.005 Lux @ (F1.6, AGC ON), 0 Lux with IR on			
	Infrared (IR)	Yes			
	IR range	Up to 40 m			
	IR wavelength	850 nm			
Encoding	Video streams	3			
	Main stream compression	H.264, H.265, H.265+			
	Sub stream compression	H.264, H.265, MJPEG			
	Third stream compression	H.264, H.265			
	Video bit rate	32 to 8 Mbps			
	Main stream resolutions	1280 x 720 (XVGA), 1920 x 1080 (1080p), 2688 x 1520		1280 x 720 (XVGA), 1920 x 1080 (1080p), 2688 x 1520, 3200 x 1800, 3840 x 2160	
	Sub stream resolutions	640 x 360 (nHD), 640 x 480 (VGA)			
	Third stream resolutions	1280 x 720 (XVGA), 640 x 360 (nHD), 640 x 480 (VGA)		1280 x 720 (XVGA), 1920 x 1080 (1080p), 640 x 360 (nHD), 640 x 480 (VGA)	
Max. resolution @ fps	2688 x 1520 @ 25/30 fps		3840 x 2160 @ 20 fps		
Lens	Lens type	Fixed			
	Focal length	4 mm, horizontal FoV 87°, vertical FoV 46°, diagonal FoV 104°			
	f-stop	F1.6			
	Auto iris	No			
	Auto focus	N/A	Yes	N/A	Yes
	Motorised zoom	N/A	Yes	N/A	Yes

Technical Specifications

TruVision 4MP, 8MP

		TVGP-M01-0401-BUL-G	TVGP-M01-0402-BUL-G	TVGP-M01-0801-BUL-G	TVGP-M01-0802-BUL-G
					
Network	Network interface	RJ-45 10/100 Mbps self-adaptive Ethernet interface			
	Integration	ONVIF Profile G, ONVIF Profile S, ONVIF Profile T			
	Supported network protocols	802.1x, Bonjour, DDNS, DHCP, DNS, FTP, HTTP, HTTPS, ICMP, IGMP, IPv4, IPv6, NTP, PPPoE, QoS, RTCP, RTP, RTSP, SMTP, SNMP, TCP/IP, UPnP			
Storage	Local storage type	Built-in Micro SD/SDHC/SDXC card slot			
	Max. SD card capacity	256 GB			
Video Intelligence	Alarm trigger	HDD error, HDD full, Invalid login, IP address conflict, Motion detection, Network disconnected, Video tampering			
	ROI	Support 1 fixed region for main stream and substream			
	Video analytics	Advanced motion detection, Audio exception detection, Defocus, Face detection, Intrusion detection, Line crossing detection, Object removal detection, Region entrance detection, Region exiting detection, Scene change detection, Unattended baggage detection			
Electrical	Operating voltage	12 VDC, 0.5 A, PoE (802.3af, 36 V to 57 V), 0.2 A to 0.13 A	12 VDC, 1.08 A, PoE: (802.3at, 42.5 V to 57 V), 0.36 A to 0.27 A	12 VDC, 0.5 A, PoE (802.3af, 36 V to 57 V), 0.2 A to 0.13 A, PoE(802.3af, class 3)	12 VDC, 1.08 A, PoE: (802.3at, 42.5 V to 57 V), 0.36 A to 0.27 A
	Power consumption	max. 7 W	max. 15 W	max. 7.2 W	max. 15 W
Physical	Physical dimensions	Ø70 x 161.7 mm Ø2.8 x 6.4 in.	Ø308.5 x 97.9 x 93 mm Ø12.2 x 3.9 x 3.7 in.	Ø70 x 161.7 mm Ø2.8 x 6.4 in.	Ø308.5 x 97.9 x 93 mm Ø12.2 x 3.9 x 3.7 in.
	Net weight	490 g 1.1 lb.	1390 g 3.1 lb.	490 g 1.1 lb.	1390 g 3.1 lb.
	Shipping weight	724 g 1.6 lb.	1390 g 3.1 lb.	724 g 1.6 lb.	1390 g 3.1 lb.
	Colour	Grey			
	Material	Aluminium			
	Form Factor	Bullet			
Environmental	Vandal proof	Yes			
	Impact rating	1K10			
	Environment	Outdoor			
	Operating temperature	-30 to +60°C -22 to +140°F			
	Relative humidity	<95% (non-condensing)			
	IP rating	IP67			
Regulatory	Compliancy	CE, FCC, REACH, RoHS, UL, WEEE			

Technical Specifications

TruVision 4MP, 8MP

National Sales Enquiries
10 Ferntree Place
Notting Hill, Victoria 3168
Phone: 1300 361 479
Outside Australia: +61 3 9239 1200

Dimensional Diagram

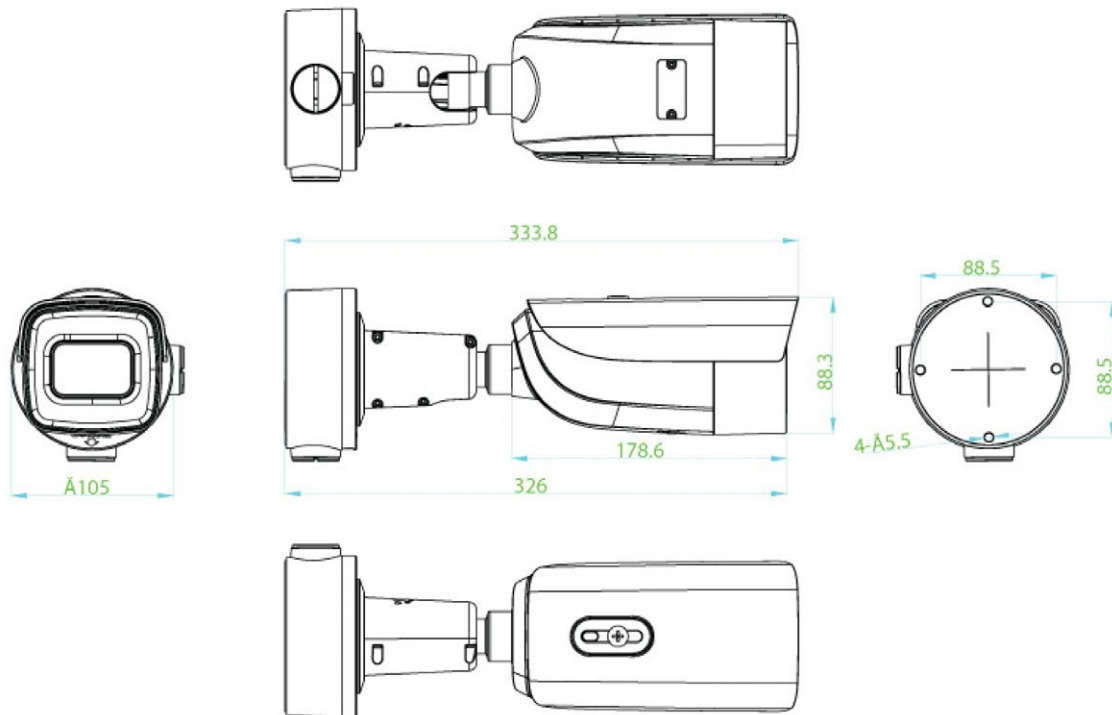

Ordering Information

TVGP-M01-0401-BUL-G	TruVision 4MP, H.265+, Smart IP Bullet Camera, 40m IR, 4mm lens, grey
TVGP-M01-0402-BUL-G	TruVision 4MP, H.265+, Smart IP Bullet Camera, 60m IR, 2.8-12mm lens, grey
TVGP-M01-0801-BUL-G	TruVision 8MP/4K, H.265+, Smart IP Bullet Camera, 40m IR, 4mm lens, grey
TVGP-M01-0802-BUL-G	TruVision 8MP/4K, H.265+, Smart IP Bullet Camera, 60m IR, 2.8-12mm lens, grey



Specifications subject to change without notice.
Carrier Fire & Security Australia Pty Ltd.
© 2022 Carrier. All rights reserved. All trademarks are the property of their respective owners.



TruVision_IP_bullet_cameras_June22