

User Manual

ALPR Parking



For Inquiries, Please contact:

Security Shop
Vladimira Popovica 6/6/A606
11070 Novi Beograd, Serbia
Tell: +381 11 318 68 68
office@securityshop.rs

Imported/Distributed by Security Shop doo
Licensed by Blaupunkt, 31785 Hameln/ Deutschland
Delivery and After Service shall only be covered within Serbia
www.blaupunkt.com
Made in China

Enjoy it.

Contents

- 01** Installation Preparation
- 02** Hardware Installation
- 03** Software Installation
- 04** Debugging

01

**Installation
Preparation**



Installation
environment
confirmation



Hardware
Preparation



Preparation of
installation tools

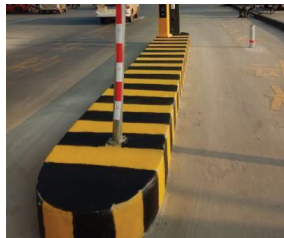

Construction
preparation

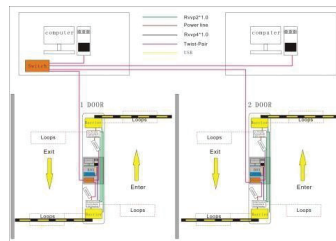

Diagram

- **Number of each entrances and exits**

Considering the number of entrance and exits, and configure the corresponding hardware to ensure that the equipment runs efficiently.

- **Distance between each entrances and exit**

The wiring distance between any two entrances and exits should not be too long, as more than 120 meters, the network communication requires optical fiber to ensure network operation efficiency.

- **Location of toll center**

In principle, the charging center should be set at a suitable point to facilitate the users of the parking lot to pay fees and handle special circumstances. Therefore, it should not be too far away from vehicle entrances and person entrances channels. Export payment, central payment or self-service terminal payment will have a huge effect on the overall system configuration and installation design.

- **Whether there is a turn at the entrance or exit and its distance**

Turning has a great influence on the position and angle of the camera at the entrance and exit, it's better to provide photos of the site for judgment.

- **Whether the entrance and exit are slopes and underground and its angle**

The slope has an influence on the camera installation position and angle, and whether the ground sense coil can be installed smoothly. Provide the site photos for judgment.

- **Whether the management office allows ground construction and buried lines**

If the management office does not allow construction on the ground, the ground-sensing coils of the barriers are replaced with microwave radar.

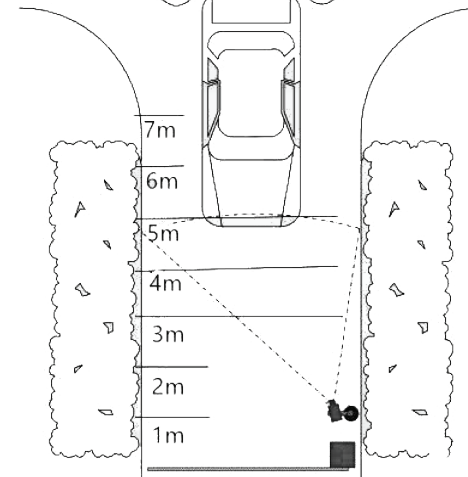
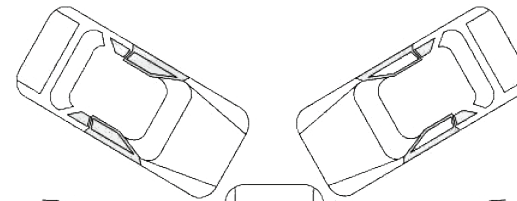
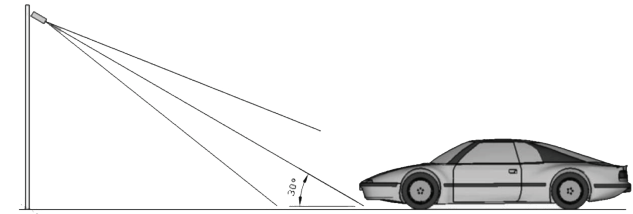
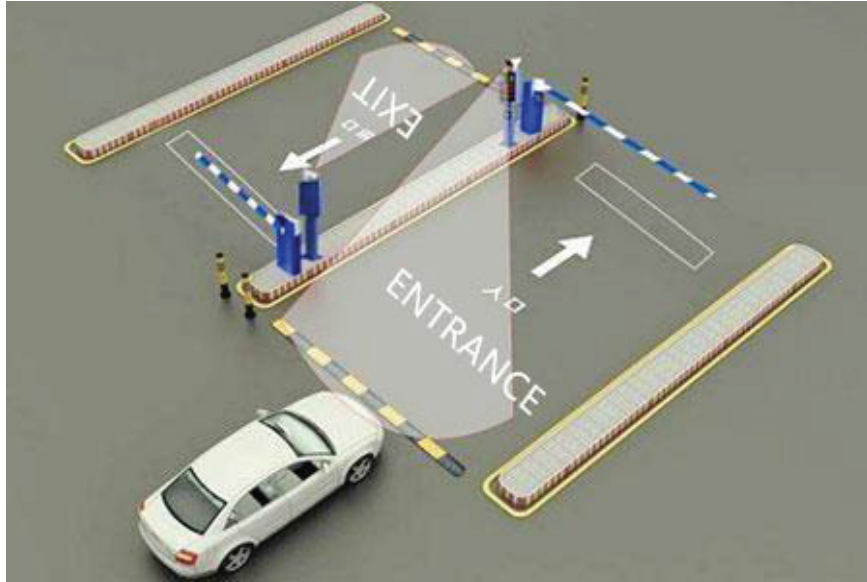
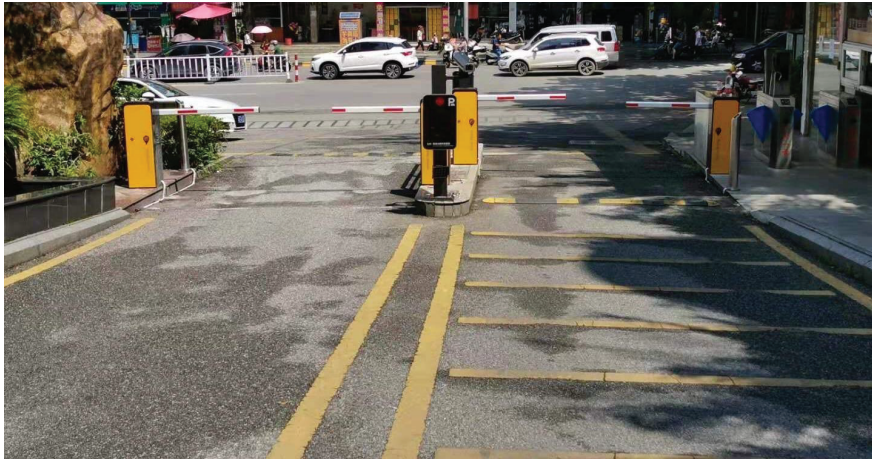

- There is no turn of the lane, the recognition distance shall be 4-5 meters from the camera horizontal line, and the vertical angle should not exceed 30 degree, the horizontal angle not exceed 55 degree.

- When there is a turn, leave enough space for the vehicle to turn to ensure that the vehicle is straight before entering the recognition area.

- If there is a distance of 4-5 meters before entering the slope, it is recommended that the entrance and exit be installed before entering the slope. Please be careful to avoid backlighting.

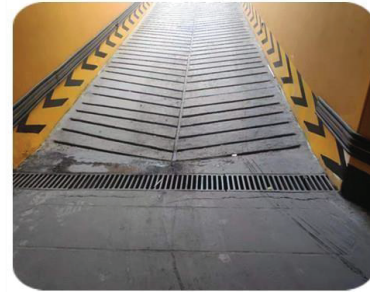

- If there is not enough distance, the equipment can be disassembled to choose a suitable installation location. Confirming the camera's recognition distance of 4-5 meters, and adjust the camera's elevation or depression to ensure that the license plate is displayed horizontally in the lens. Generally, the angle of a straight slope does not exceed 15%, and the angle of a curved ramp does not exceed 12%. During construction, the installation angle of the camera can be adjusted according to the angle of the slope.

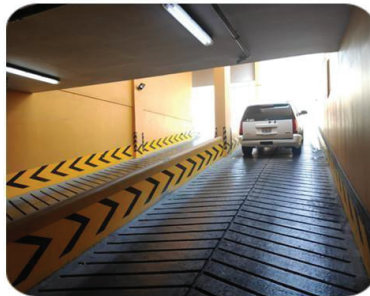

- The position of the ground sensing coil and the vehicle detector in the slope can be constructed according to the texture of the slope. If the site conditions permit, the ground sensing coil should be constructed on a level ground as much as possible.



- If the camera's position is somewhere above the slope, then two reduction gear should be installed at 6 and 7 meters from the camera's horizontal line to ensure that the vehicle's travel speed is less than 30km / h. At the exit, the installation principles are similar, but only one reduction gear is required at 6 meters.

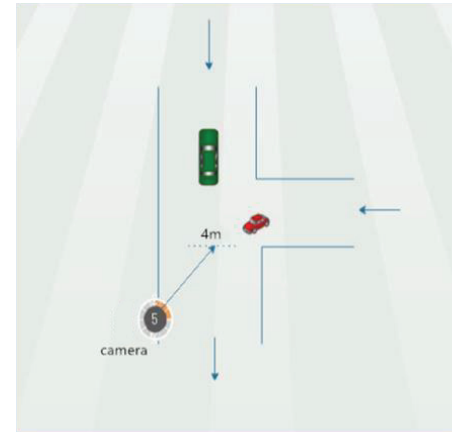
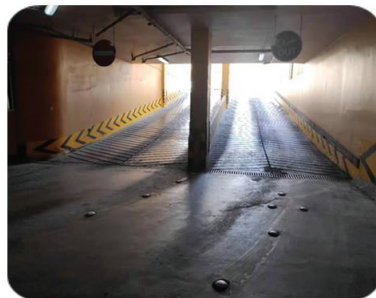

One-way T-junction

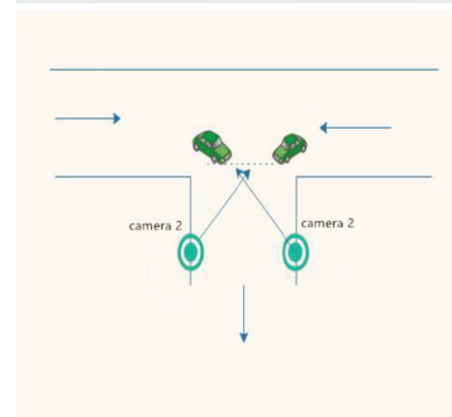

Two way T junction

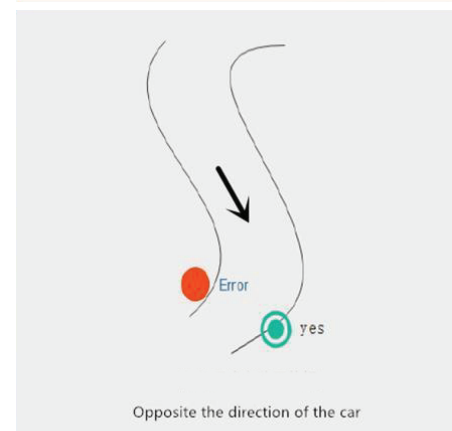

S curve

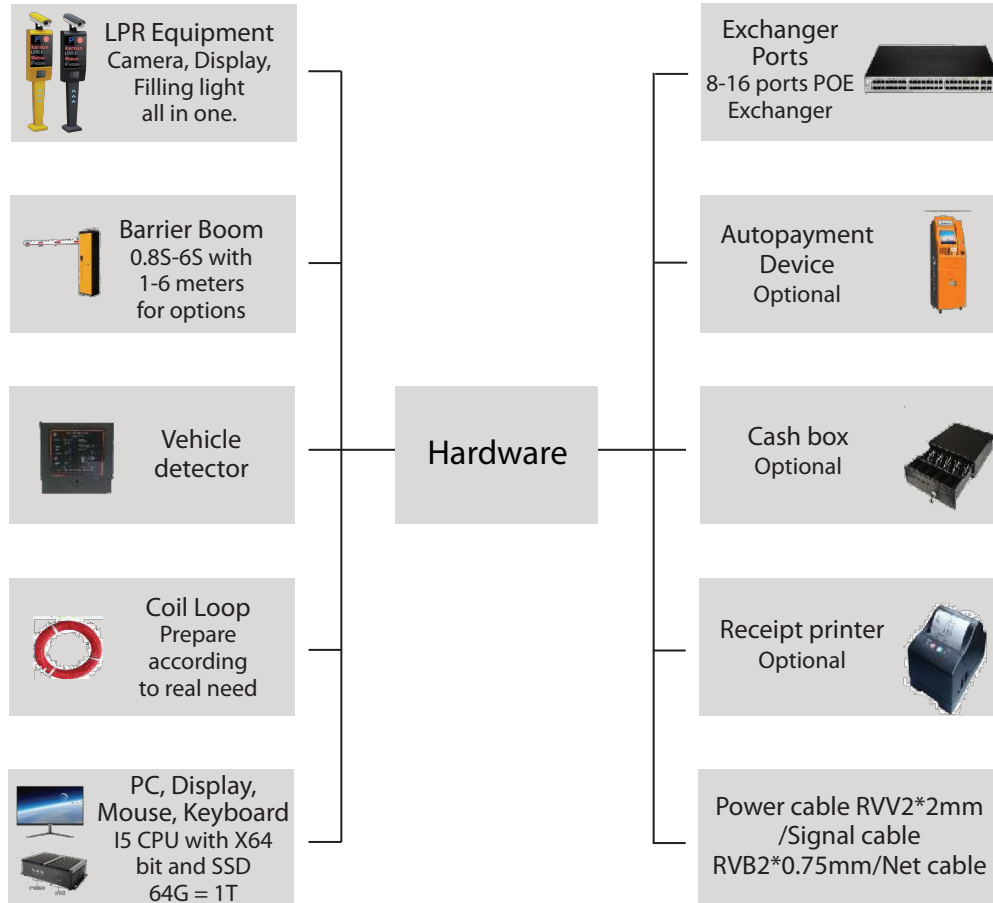

Wire stripper



Network pliers



Allen wrench



Screwdriver



Drill



Cement cutting machine



1. Before construction of the safety booth, the design and construction drawings need to be determined according to the actual situation on the site, the size of the equipment and the requirements of the constructor. (Location, routing, wiring).

2. Wiring diagrams need to take into account factors such as the location of power draw, pipeline consumables, and metal objects.

3. Pipe routing principles: Minimal lines and pipes, no bending, smooth connection.

4. PVC pipe size: 4 pipe, 6 pipe, 2 inch pipe, elbow.

5. The general height of the safety island is 15-20 cm, and the length and width are determined according to the installation distance of the equipment and the maximum width or length.

6. The layout of the pipe considers that the ground sense coil access is reserved. The coil in the same lane are separated by more than 1 meters. Each ground sense coil has a different number of windings.

7. The cement: stone: water ratio of Cement Island is 1: 2: 3.

8. The safety island is generally in the middle of the road.



Security booth foundation and guard booth

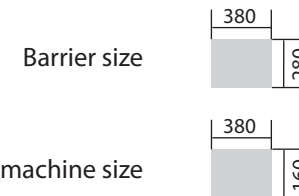
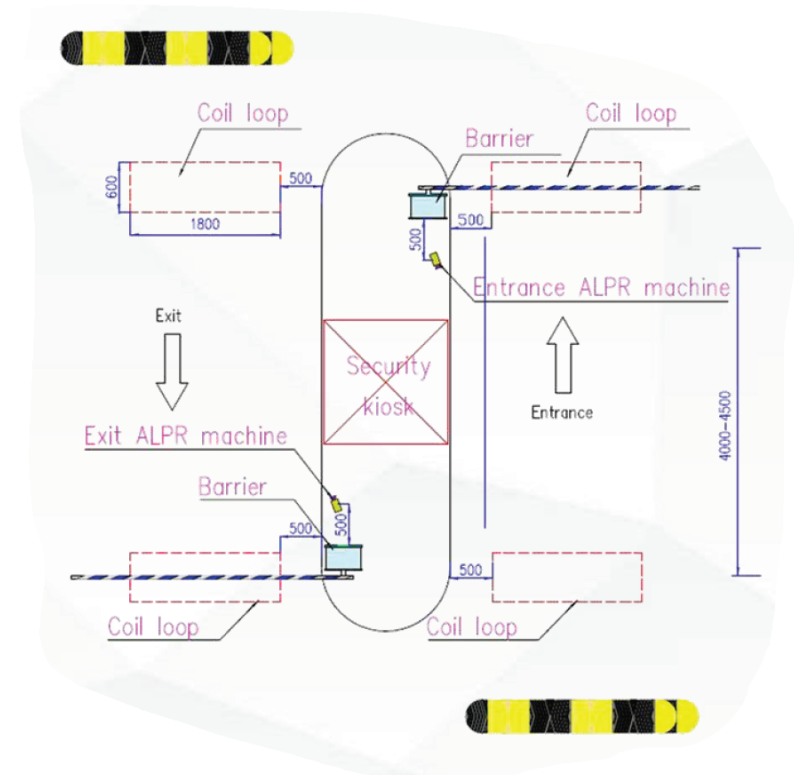

Note:

1. The toll station made of cement with height 200mm.
2. The recognition distance shall be 4000 - 5000 (mm).
3. Coil loop is not necessary for straight lanes without slope and curve.

Unit: mm

1. Before construction of the coil loop, the position, size and number of turns shall be confirmed according to the overall wiring arrangement of the project. The number of turns does determine the inductance of the entire coil between 100-200 (UHF), and 150-180 (UHF) is recommended to ensure the perfect working range of the vehicle detector.

2. The coil loop must not damage the protective layer. Use a digital meter to measure the resistance to ground is greater than or equal to $10M\Omega$, and the DC resistance is 4-6 Ω .

3. There must not be a large amount of metal in the surrounding 50 cm, such as well covers, rain gutter covers, etc.

4. There must not have the power supply lines of 220V within 1 meter.

5. When making multiple coils, the distance between the coils should be greater than 2 meters, and the number of turns should not be equal to each other, otherwise they will interfere with each other.

6. Make 45-degree chamfers on the four corners and smooth them to prevent sharp corners from damaging the coil cable.

7. The cable length should be calculated in advance and sufficient margin should be reserved (including the coil lead-out wire). Between connectors, cables must not be broken. Route the cables as far as possible at the bottom of the slot, and arrange the cables in an orderly manner, without crossover or overlap.

8. The lead wire from the coil to the "ground sensor" should be twisted at more than 20 cycles / meter, and the distance between the lead and the ground sensor should be as short as possible (if the lead at this end is too long, it will cause Ground sensitivity is reduced), it is recommended that this section be within 1 meter and the maximum should not exceed 5 meters.

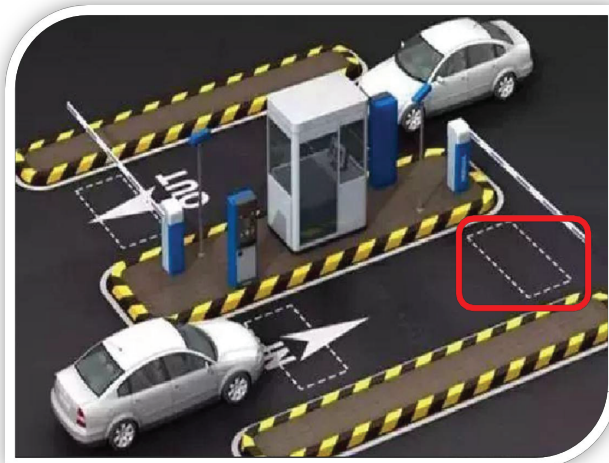

Coil loop

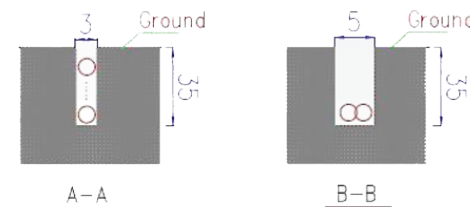
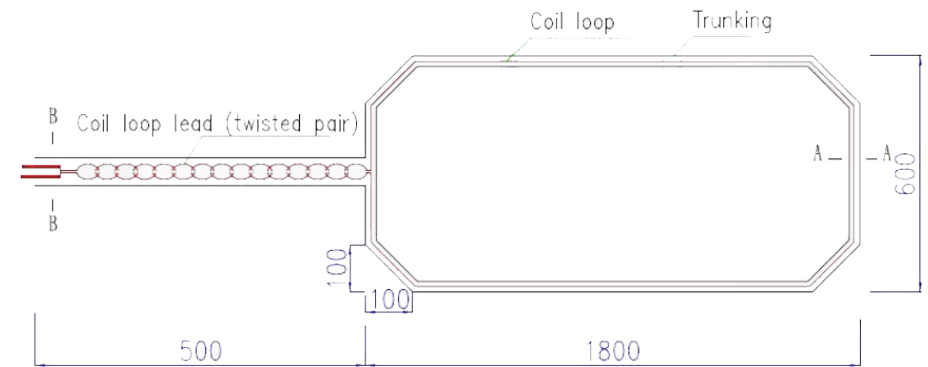

Note:

1. Making a rectangular wire trunking of width 3-5mm, the 4 corners shall be smoothly turning, and the leading wire trunking width 5-8mm. Cleaning the dust and dross after finished the cutting.
2. The ground sense coil is tightly wound along the inner wall of the groove.
3. The ground-sensing coil is wound on average 4-6 times, with a buried depth of 35-50mm.
4. Twist the coil leads to the terminals of vehicle detector in the lpr all in one machine or the barrier gate.
5. The ground sense coil loop (including the lead-out wire) is directly sealed and fixed by dry cement or asphalt without any pipe.
6. The ground-sensing coil must be carefully inspected before being buried, and it must not be damaged or the copper wires exposed.

Unit: mm

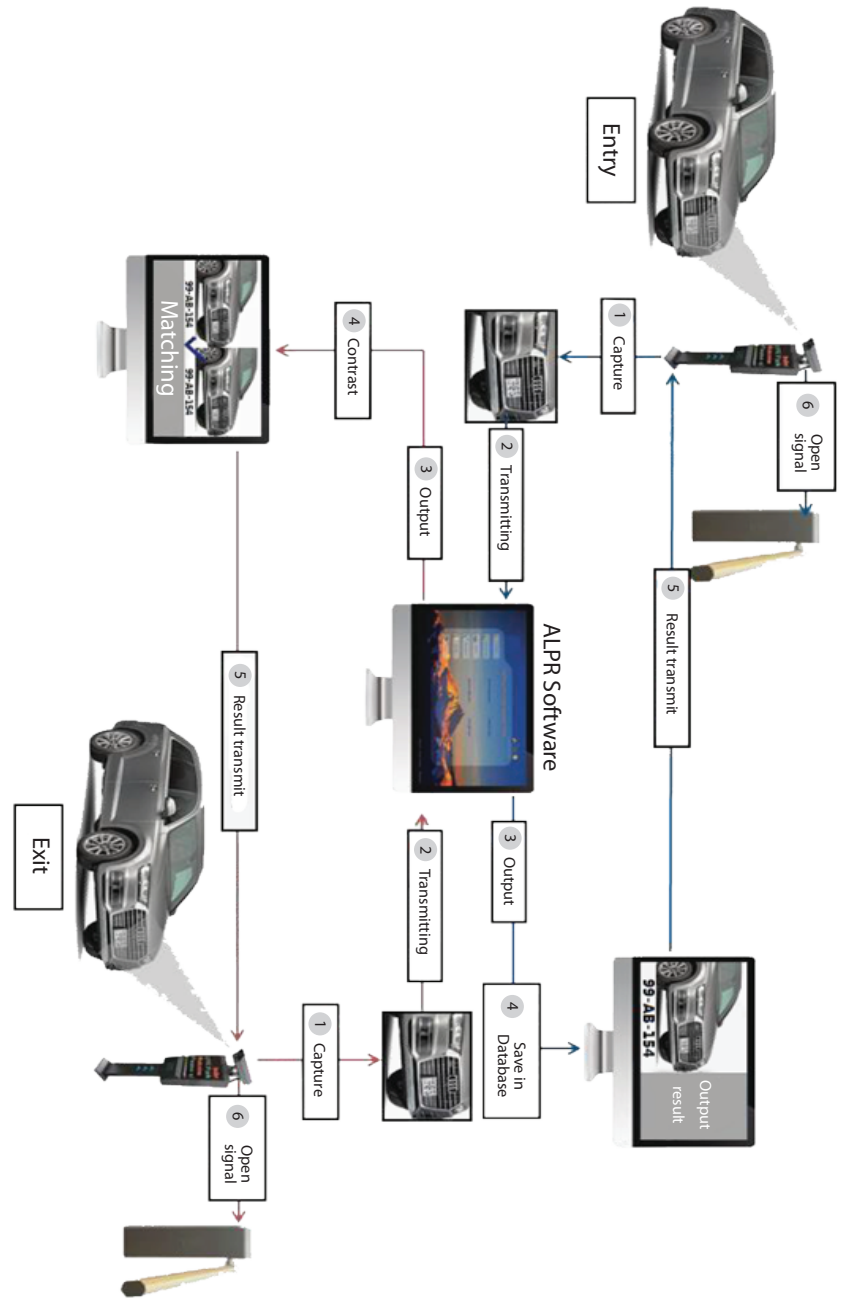
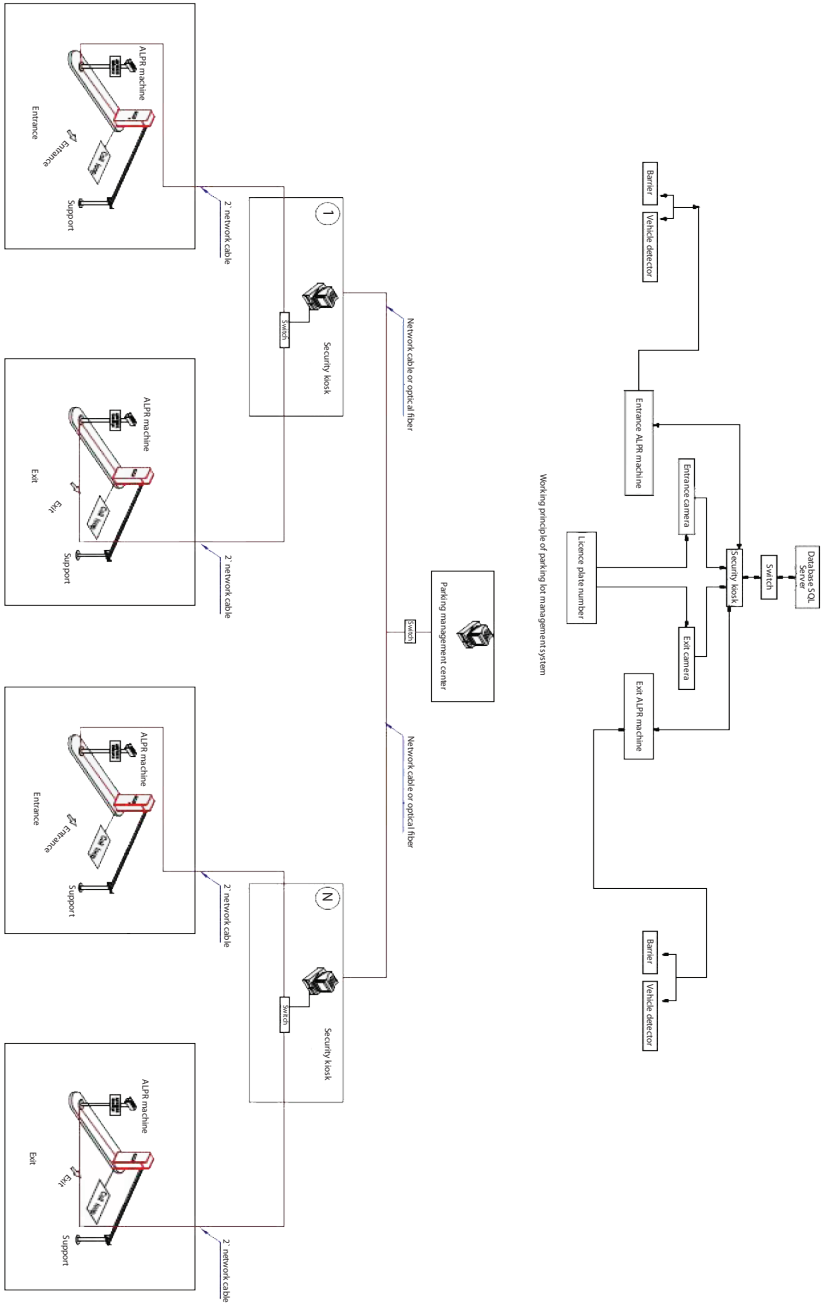

Hardware Installation

02

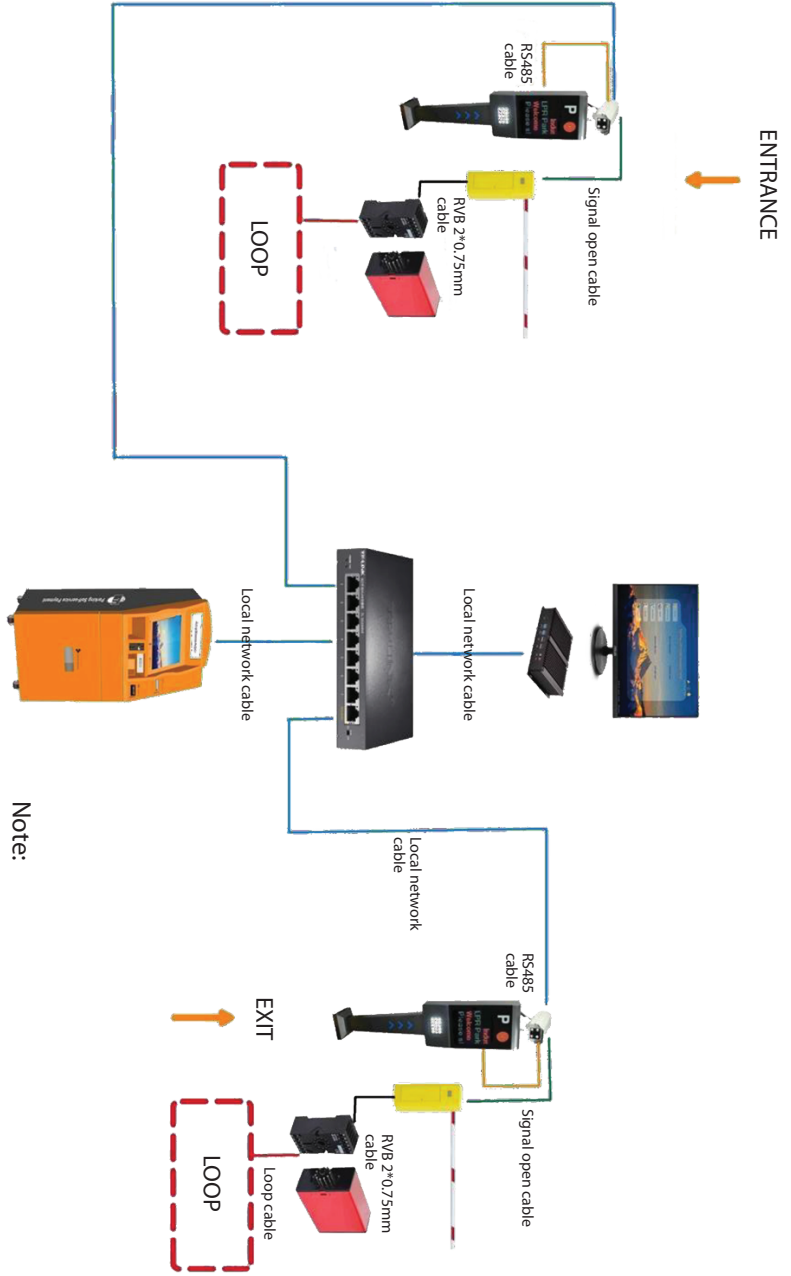

Note:
 alpr all in one machine, barrier, pc, switch,
 autopayment machine shall connect with
 power supply 220-240V/1 10V.

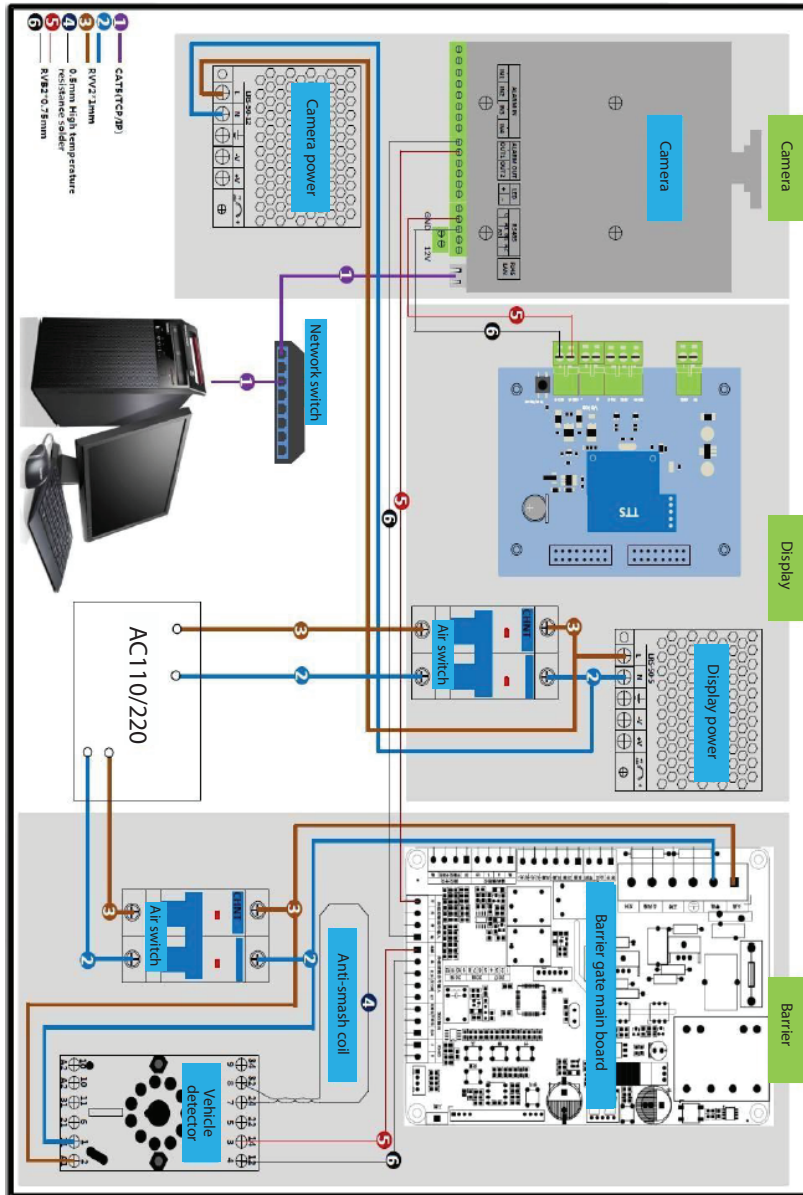

The license plate recognition integrated camera's top-down angle to the recognition area cannot be greater than 40 degrees.
 The angle between the vehicle license plate recognition integrated camera and the vehicle traveling in a straight direction cannot be greater than 45 degrees, and the parallel angle between the license plate and the recognition area of the vehicle license plate recognition integrated machine within the recognition area cannot be greater than 15 degrees.

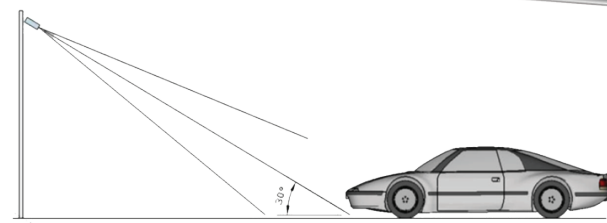
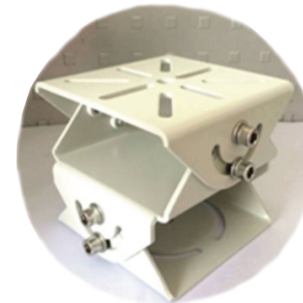



Search camera IP automatically, fill in camera username and password automatically



Video output, manual capture and automatic capture are optional



Image pixels debugging, snap direction and area setting



Network debugging

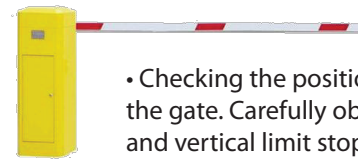
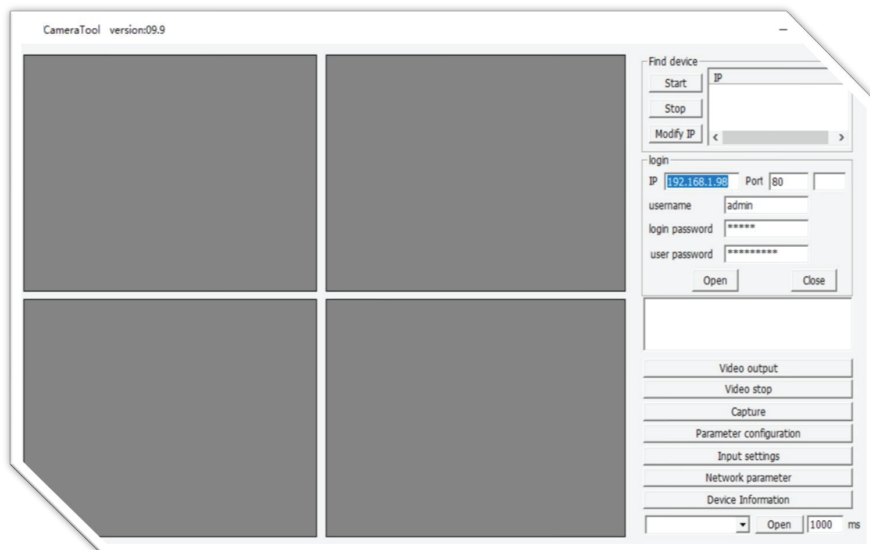

- Checking the position of the boom: Use controller switch to lift and lower the gate. Carefully observe whether the boom is accurate in the horizontal and vertical limit stop positions. If there is an error, adjust the position of the limit switch.

- Opening operation: When the boom is in a stationary state that is not in place, press the start button of the triple button. At this time, the brake lever will rise and it should stop in the vertical position.

- Closing operation: The boom is in the static state when it is not closed in place. Press the close button of the controller. At this time, the boom will fall and stop at the horizontal position.

- Stop operation: During the opening or closing process, the intelligent remote control stop button, the brake lever should stop immediately

- Anti-smashing test: Open the brake lever in place, and press the closing button to simulate the ground of the vehicle under the road brake (can be simulated with iron blocks). The brake lever should immediately stop landing and open the brake.



- When the detector is powered up, it will automatically detect and tune to the connected coil. This process takes about 5 seconds, while the LED on the top panel flashes quickly.

- The detector will test the coil during the tuning process. When the LED on the top panel flashes at a frequency of 1HZ, the detector enters the normal working state (at this time, the relay does not pull in)

- When the detector detects the arrival of a vehicle, it will engage the relay corresponding to the standard output and light up the corresponding LED indicator; when the vehicle leaves, it will release the relay corresponding to the standard output and turn off the corresponding LED indicator.

- If the detector does not respond when the coil is inductive, double check the detector for crashes, and then check whether the coil is working properly.

03

Software Installation

Computer



Database



Software Dongle



Normal PC Requirement
win7 win10 X64 bit operating system,
cpu above i3 supports AVX instruction set,
memory 4-8G

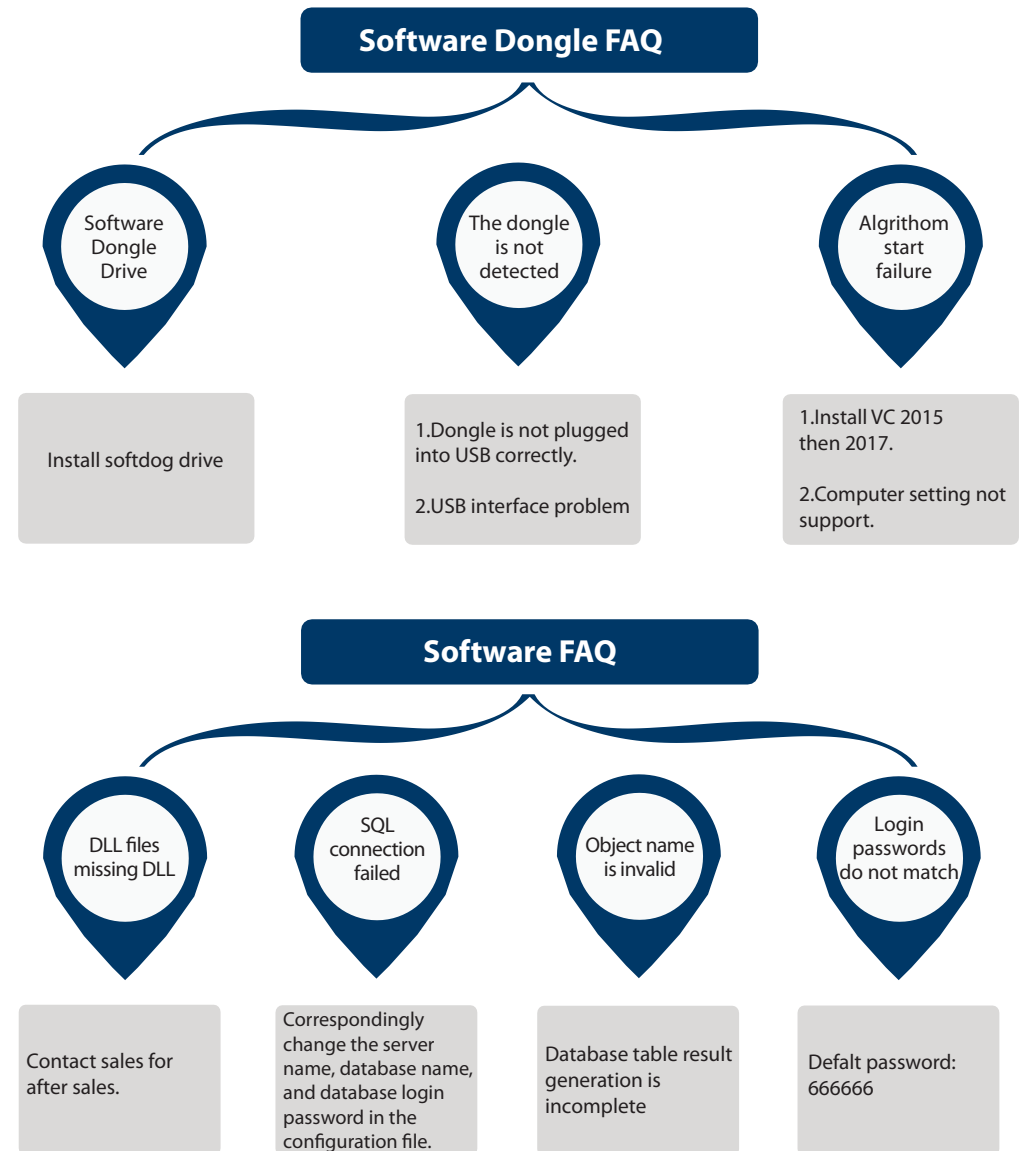
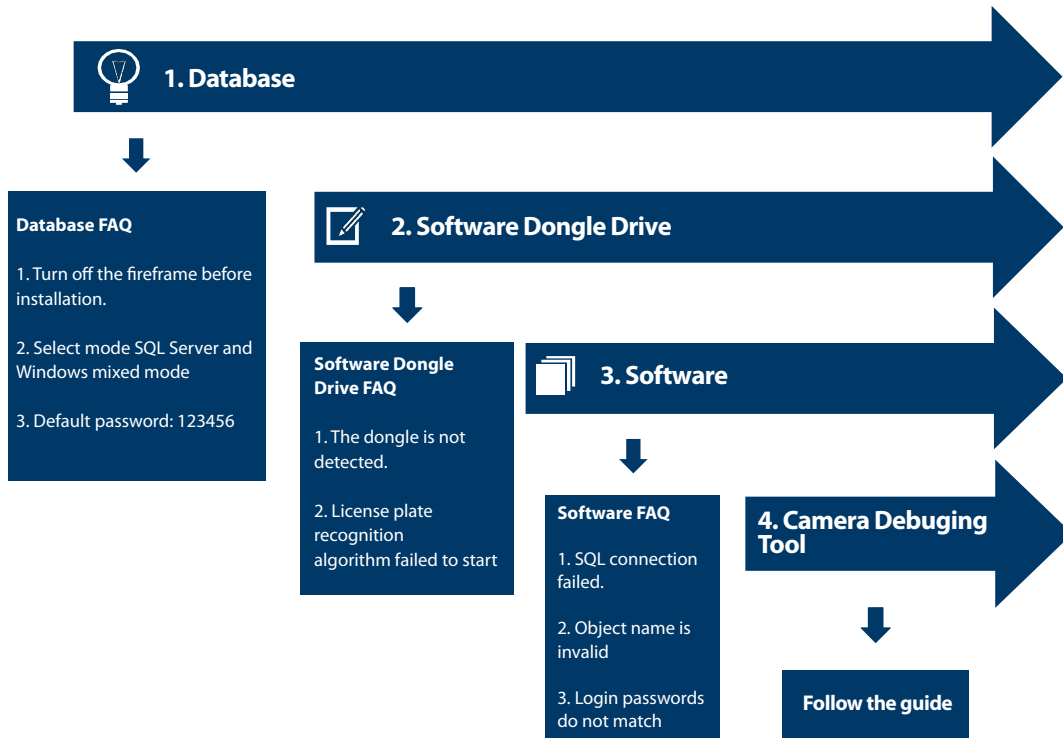

04

Debugging

1. Before debugging the device, please turn off the computer firewall.
2. The camera IP is affixed to the camera case, and the camera IP is input to the setting of the software.
After the connection is normal, you can see the camera dynamic screen in surveillance.
3. Server, management PC, camera must be in the same LAN segment, such as 192.168.1.2
4. Network operation test, enter the operation interface, enter "cmd", check whether the computer and camera network operation returns to normal.
5. Park a car on the alpr recognition area or detection coil, take a snap shot and trigger test, adjust the recognition distance and pixels, and ensure that the pixel height of the license plate characters is 30-40 pixels.

The screenshot displays a parking management software interface with multiple camera feeds and data tables. The top left shows a camera feed of a parking lot with a license plate '1810YHY'. The top right shows a camera feed of a white car with license plate '0705YHH'. The bottom left shows a table of current records and a table of entrance/exit exceptions. The bottom right shows a control panel with buttons for 'Free Vehicle(F9)', 'Confirm(F10)', and 'Cancel(F11)'. The bottom right corner shows the date and time: '05/22/2019 18:52:37 Wednesday Administration'.

Vehicle No.	Entry time	Type of car	Valid date
1810YHY	05/22/2019 18:52:14	Temporary	
6183YDO	05/22/2019 18:51:54	Temporary	
7736YHL	05/22/2019 18:49:28	Temporary	

Vehicle No.	Entry time	Exit time
7059T A	05/22/2019 18:48:59	05/22/2019 18:48:59
4877YHA	05/22/2019 18:37:31	05/22/2019 18:45:51