



User Manual

MINI OUTDOOR STATION
BP-VDP-OS124-B



Enjoy it.

Attentions

- 1、 Please keep devices away from strong magnetic field , high temperature , wet environment ;



- 2、 Please do not fall the devices to the ground or make them get hard impact ;



- 3、 Please do not use wet cloth or volatile reagent to wipe the devices ;



- 4、 Please do not disassemble the devices.

Content

Chapter 1	Function Overview	1
1.1	Function	1
1.2	Parameter	1
Chapter 2	Product Introduction	2
2.1	Product Appearance	2
2.2	Interface Description	3
Chapter 3	Installation	4
3.1	Installation Height	4
3.2	Installation Steps	5
Chapter 4	Settings	6
4.1	Pairing of Mini Outdoor Station and Indoor Monitor	6
4.2	Card Management	7
4.3	Key Synchronization	8
4.4	Unlock Time Setting	9
4.5	Interaction with Disarming	9
4.6	Door Status Alarm	9
4.7	Door Status Warning Tone	10
4.8	Anti-dismantle Alarm	10
Chapter 5	User Instruction	11
5.1	Calling Resident	11
5.2	Call Guard Unit	11
5.3	Unlock	11

Chapter 1 Function Overview

The product is the mini outdoor station of the H Series Digital System VDP. By using standard CAT5 cables, it makes visual intercom call to indoor monitor and guard station possible. Besides, it supports IC card access control.

1.1 Function

- Support IC card
- Support calling to indoor monitor and guard unit
- Adjustable unlock time
- Door status detection, and unlock state timeout alarm.
- Support normal open/close unlock output
- Support online update.

1.2 Parameter

Working Parameter

Working Voltage: DC 24V

Working Current: $\leq 130\text{mA}$

Storage Temperature: $-40^{\circ}\text{C}\sim 70^{\circ}\text{C}$

Static Current: $\leq 60\text{mA}$

Working Temperature: $-20^{\circ}\text{C}\sim +55^{\circ}\text{C}$

Dimension(W/H/D): $120\times 194\times 44.7\text{mm}$

Camera

Type: CMOS

View Angle: Diagonal 95°

Focus Length: 2.2mm

Adjustable Angle: up/down/left/right 12°

Pixel: 0.3 Mega

Min. Illumination: 0 lux

Fill-in Light Type: white

Chapter 2 Product Introduction

2.1 Product Appearance

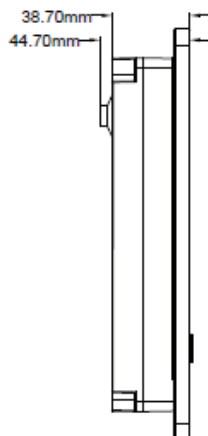
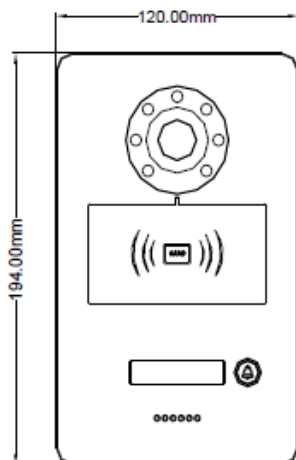
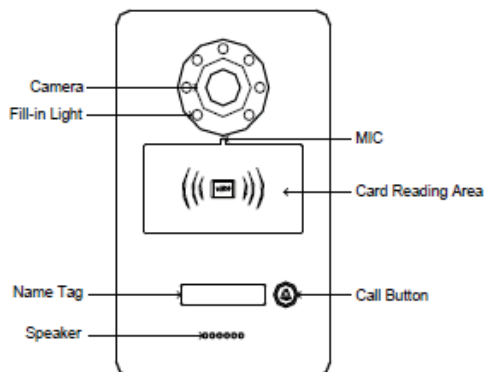

2.2 Interface Description

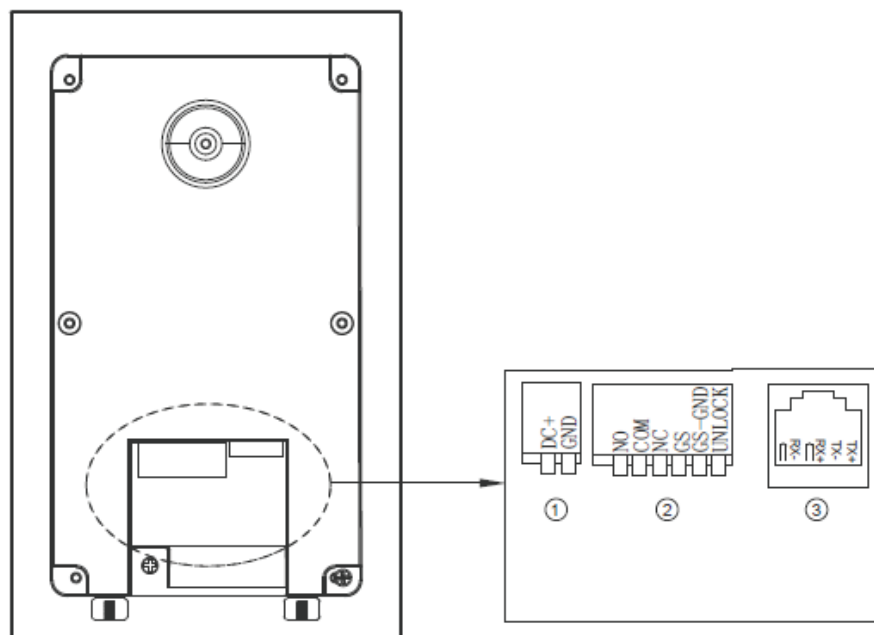

①

GND, DC+: independent power supply interface;

②

GS, GS-GND: door status detection interface;

NO, COM, NC: normal open/close interface;

③

RJ45: cable interface, connecting non-standard 24V POE switch.

Chapter 3 Installation

3.1 Installation Height

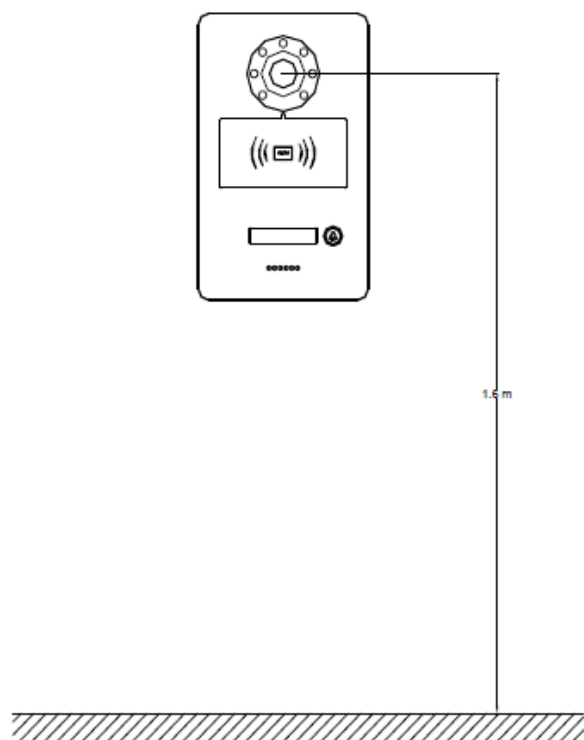

Suggested Installation Height: camera is 1.6m above the ground

3.2 Installation Steps

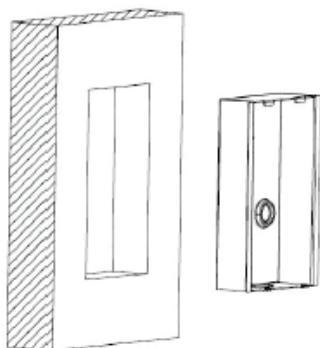

Step 1:

Embedded box slot on the wall.

Embedded box dimension (W/H/D) :

100.6 x 175.5 x 38.7mm

Step2:

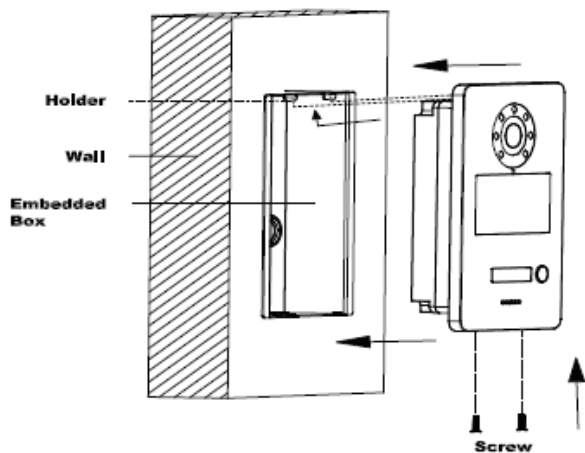

Fix the embedded box into the slot, and fasten with screws. Then wire the outdoor station and press it into the embedded box.



Chapter 4 Settings

4.1 Pairing of Mini Outdoor Station and Indoor Monitor

Within 3 minutes after powering the mini outdoor station, long press the keypad until 3 times short beeps, then short press the keypad with a long beep to enter setting.

Press  in indoor monitor \Rightarrow project setting (code: 801801), then choose mini outdoor station 1 or mini outdoor station 2 for setting, which brings to the mini outdoor station setting page. Follow the instruction and choose device on the right then press icon , afterwards the mini outdoor station and indoor monitor are paired successfully.

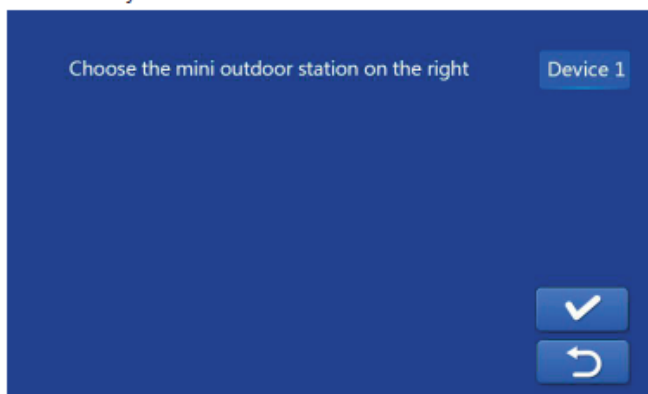

Configuration interface of mini outdoor station

Note: when connection done, the icon of mini outdoor station will be highlighted in indoor monitor relevant page.

4.2 Card Management

Press  in indoor monitor \Rightarrow Mini Outdoor Station setting, input the password to access to setting, choose card management to enter card management interface.

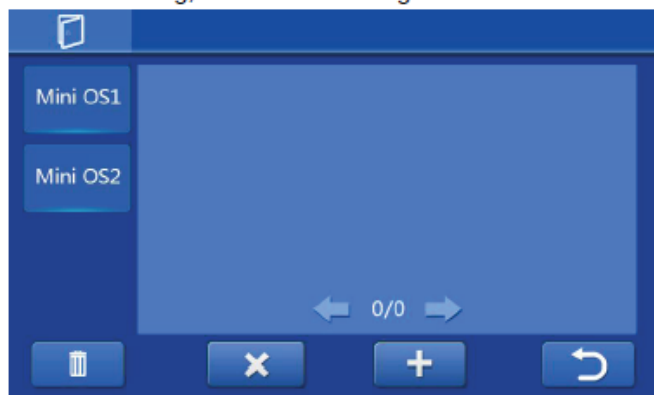

Card Management Interface

Choose the mini outdoor station needs to be set, details of functions of icon below:

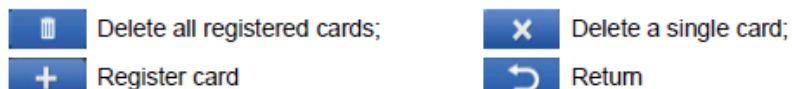

After choosing icon , put the IC card to the card reading area of mini outdoor station. After a short beep, the card will be registered. Return to the indoor monitor page, you will see the registered card number.



Interface of card reading notice

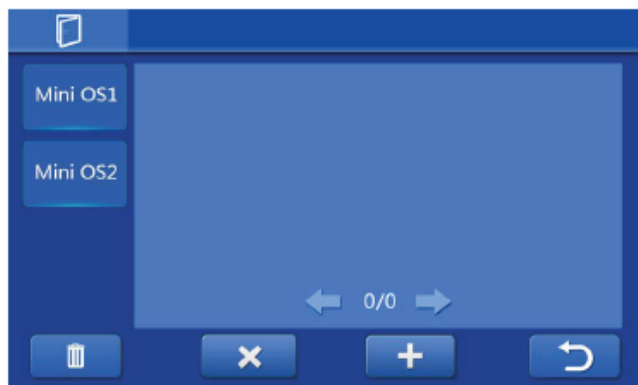

Interface of registered card (with card number)

4.3 Key Synchronization

In the case of multiple extension of indoor monitors in one apartment, if only one indoor monitor has been paired with the mini outdoor station, then that's the only indoor monitor which can unlock the door and owns the admin. rights, in which case, only this indoor monitor shows a highlighted mini outdoor station icon in relevant page while other indoor monitors not.

If you need to copy this admin. rights and unlock permission to other indoor monitors in the same apartment, then key synchronization is needed

Operation: enter the mini outdoor station management page of the monitor with admin. rights, Then chose key synchronization. Process is shown as below:

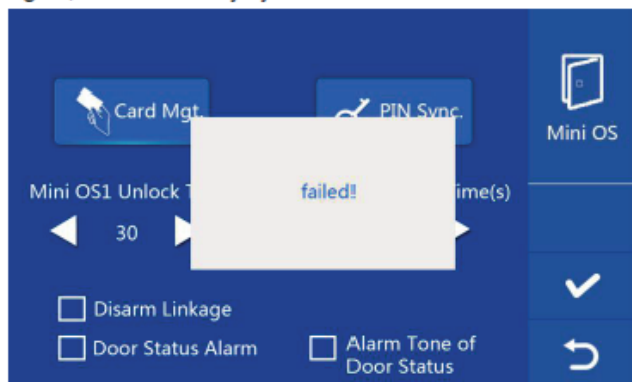

Key sync succeeded

4.4 Unlock Time Setting

Enter interface of mini outdoor station management to set unlock time, range: 5~30 seconds.

4.5 Interaction with Disarming

Choose disarming interaction function of mini outdoor station. When indoor monitor is armed successfully, the indoor monitor will disarm automatically if the access card opened the door successfully.

4.6 Door Status Alarm

When the door is detected opened over 120 seconds by mini outdoor station, the guard station/unit will receive an alarm alert with information of the apartment. Interface on guard unit page is shown as below:

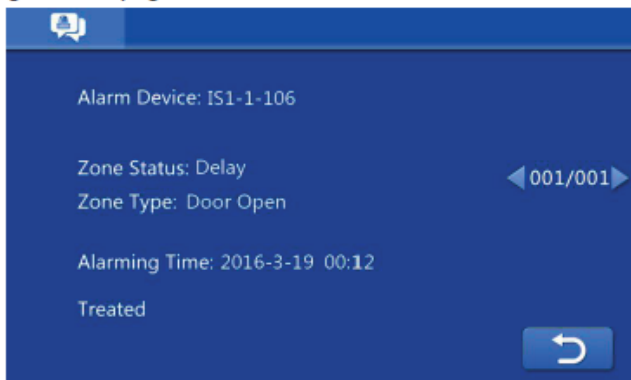

Alarm interface of door opened too long

4.7 Door Status Warning Tone

When door status warning tone is chosen, the indoor monitor will give out a warning tone when the outdoor station detected an overtime door open status.

4.8 Anti-dismantle Alarm

The anti-dismantle Alarm will be enabled when there's external force dismantling the mini outdoor station. The message sent to guard unit will include basic info of the apartment and area where the devices are under dismantling. Message details are shown as below:

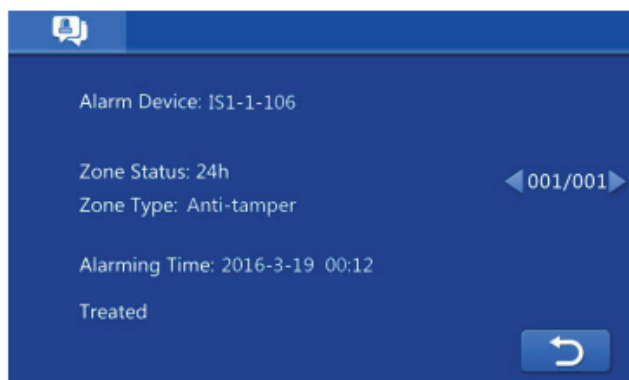

Interface of anti-dismantle alarm

Chapter 5 User Instruction

5.1 Calling Resident

By short pressing the keypad of outdoor station, visitor starts to call the indoor monitor, whose ringtone will echo back. If the keypad is short pressed again during the call, then the waiting time will be recounted (each call waits for 30 seconds); if the keypad is long pressed during the call, the call will be diverted to the guard unit/management center; if there's no answer in 30 seconds, the call will be ended.

5.2 Call Guard Unit

By long press the keypad of outdoor station for over 2 seconds, visitor starts to call the indoor guard unit/management center, whose ringtone will echo back. If the keypad is short pressed again during the call, then the call will be switched to the apartment indoor monitor; if the keypad is long pressed, then the waiting time will be recounted (each call waits for 30 seconds); if there's no answer in 30 seconds, the call will be ended.

5.3 Unlock

1. Access IC card unlock

Swipe the registered IC card on the card reading area of mini outdoor station to open the door.

2. Indoor monitor unlock

Door can be opened by indoor monitor when it's communicating with outdoor station or under surveillance mode.

3. External push button unlock

As there're interface for integration of external push buttons, when it is connected, a normal push button can be used to unlock the door.

For Inquiries, Please contact:

Security Shop doo
Vladimira Nazora 1, 11077 Novi Beograd
Tel: +381 11 318 68 68
www.securityshop.rs

BLAUPUNKT and the BLAUPUNKT logo are trademarks of TALISMAN BRANDS (Luxembourg) S.A.R.L. and are used under license from Talisman Brands, Inc. BLAUPUNKT licensees are solely responsible for the BLAUPUNKT branded products manufactured, distributed and sold under license.
www.blaupunkt.com