



User Manual

Sliding Gate Opener
BP-SLG800-24-KIT



Enjoy it.

Dear users,

Thank you for choosing this product. Please read this manual carefully before installation and use. Please do not forget to include this manual if you send the product to a third party.

1. Safety Instruction



Please make sure that the power voltage being used matches with the supply voltage of gate opener (AC110V or AC220V); kids are not allowed to touch the control devices or the remote-control unit.

The remote-control unit is single button mode or three button mode (please refer to the instructions of the remote control in accordance with the actual gate opener type). The indicator light on the remote-control unit will flicker when its button is pressed. Main machine and gate can be unlocked with a disengagement wrench and the gate can be manually operated after disengagement.

Please make sure that nobody is around the main machine or gate when the switch is operated. Please temporarily stop using the product if the main machine needs to be repaired or regulated. The installation and maintenance of the product must be carried out by professionals.







Please read this manual carefully before installing、 using、 maintaining or repairing it. Without following this manual, any injury or property losses caused by improper use or unauthorized modification is out of the responsibility of our company.

CONTENTS:

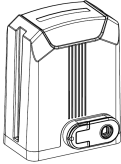
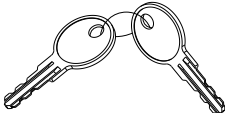
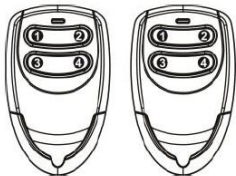
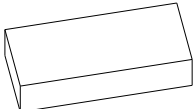
1. Safety Instruction	1
2. Packing List	3
3. Technical Parameters	4
4. Installation	5
4.1 Installation Drawing	5
4.2 Size of Main Machine and Accessories	6
4.2.1 Size of Main Machine	6
4.2.2 Size of Mounting Plate	6
4.3 Installation Procedures	6
4.3.1 Preparation Work before Installation	6
4.3.2 Main Machine Installation	7
4.3.3 Gear Rack Installation	7
4.3.4 Limit Switch Adjustment	9
5. Control Board Programming	10
5.1 Wiring Instructions	10
5.2 Digital Display Instruction	11
5.3 Potentiometer Adjustment	12
5.4 Quick Travel Setting	12
5.5 Remote Control Pairing	12
5.6 Remote Control Deletion	12
5.7 Remote Control Mode	13
5.8 Function Setting	13
5.9 Infrared Photocell Connection (optional)	14
5.10 Solar Power Battery Connection (optional)	15
6. Others	16
6.1 Maintenance	16
6.2 Troubleshooting	16

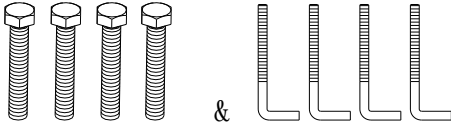
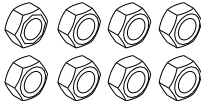
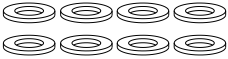
2. Packing List (standard)

No.	Picture	Name	Quantity
1		Main machine	1
2		Manual release key	2
3		Remote control	2
4		Magnetic limit switch accessories box	1
4-1		Magnetic limit switch block	1
4-2		Limit switch block mounting screw M6X18	4
4-3		Outer hexagonal bolts M8×60 Foundation bolt M8	4 4
4-4		Nut M8	8
4-5		Flat washer Ø8	8
4-6		Spring washer Ø8	8

2. Packing List (optional)

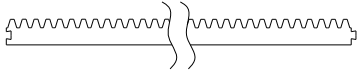
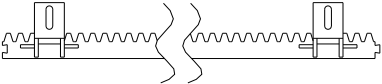
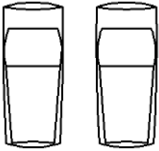
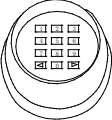
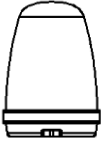
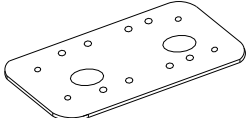
No.	Picture	Name	Quantity
1		Steel gear rack	1m/pc
2		Nylon gear rack	1m/pc
3		Infrared sensor	1
4		Wireless keypad	1
5		Alarm lamp	1
6		Mounting plate	1

3. Technical Parameters

Model	BP-SLG800-24-KIT
Power supply	220V AC/50Hz
Motor working voltage	24VDC
Motor power	170W
Gate moving speed	16-18m/min
Maximum weight of gate	800Kg
Remote control distance	≥30m
Remote control mode	Single button mode /Three button mode
Limit switch	Magnetic limit switch

Noise	≤58dB
Working duty	S2, 20min
Recording of up remote controls	25
Frequency	433.92 MHz
Working temperature	-20°C ~ +70°C
Package weight	11Kg

4. Installation

BP-SLG800-24-KIT sliding gate opener is applicable to gate weight less than 800kg, and length of the sliding gate less than 8m. The drive mode adopts the rack and gear transmission. This gate opener must be installed inside the enclosure or yard for protection.

4.1 Installation Drawing

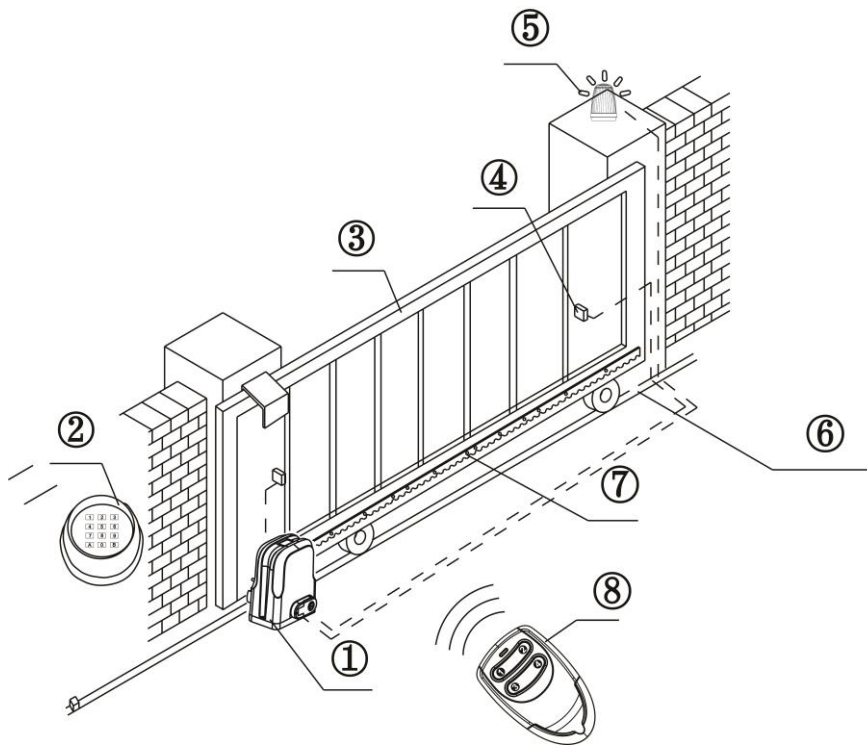

Figure 1

①	Gate Opener	③	Gate	⑤	Alarm Lamp(optional)	⑦	Gear Rack
②	Wireless Keypad(optional)	④	Infrared Sensor(optional)	⑥	Safety Door Stopper	⑧	Remote Control

4.2 Size of Main Machine and Accessories

4.2.1 Size of Main Machine

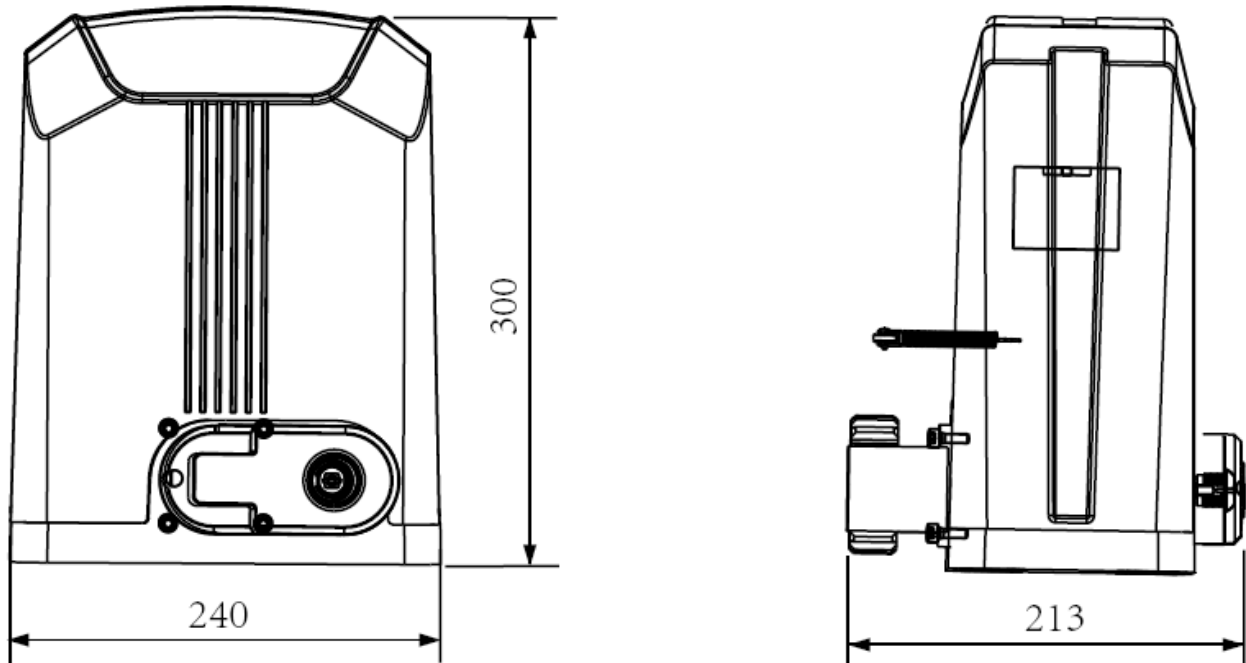

Figure 2

4.2.2 Size of Mounting Plate

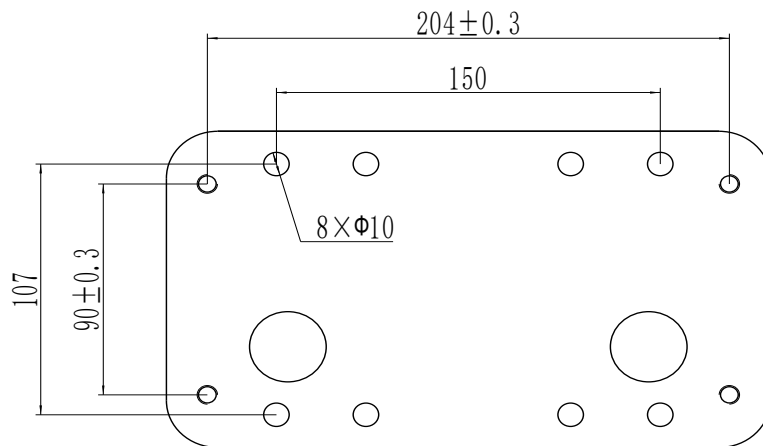

Figure 3

4.3 Installation Procedures

4.3.1 Preparation Work before Installation

Please make sure that the sliding gate is correctly installed, the gate rail is horizontal, and the gate can be manually moved smoothly before installing the gate opener.

Cable installation

In order to guarantee the normal operation of the gate opener and protect the cables from damages, please bury the motor & power cable and controlling cable separately with two PVC tubes.

Concrete pedestal

Please cast a concrete pedestal with the size can be 400mm x 250mm, depth be 200mm in advance, so as to firmly install BP-SLG800-24-KIT gate opener. **Please make sure the distance between the gate and gate opener is appropriate before casting the pedestal.**

Embedded screws

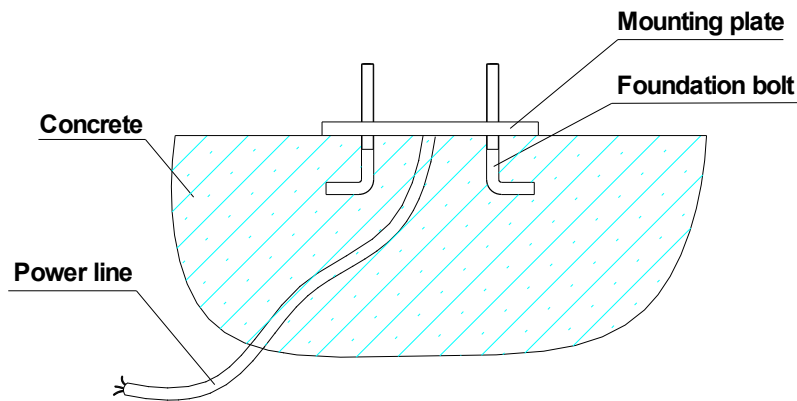

Figure 4

4.3.2 Main Machine Installation

- Dismantle the plastic housing on the main machine before installation and keep relevant fasteners properly;
- Please prepare the power line for connecting the mounting plate to the main machine (the number of power supply cable cores should not be less than 3 PCS, the sectional area of cable core should be over 1.5mm² and the length should be determined by users according to the situation on installation spot)
- Please unlock the main machine before installation, the unlock method is: remove the rubber key cover, insert the key, and open the manual release bar till it rotates by 90° as shown in Figure 5. Then turn the output gear and the gear can be rotated easily;

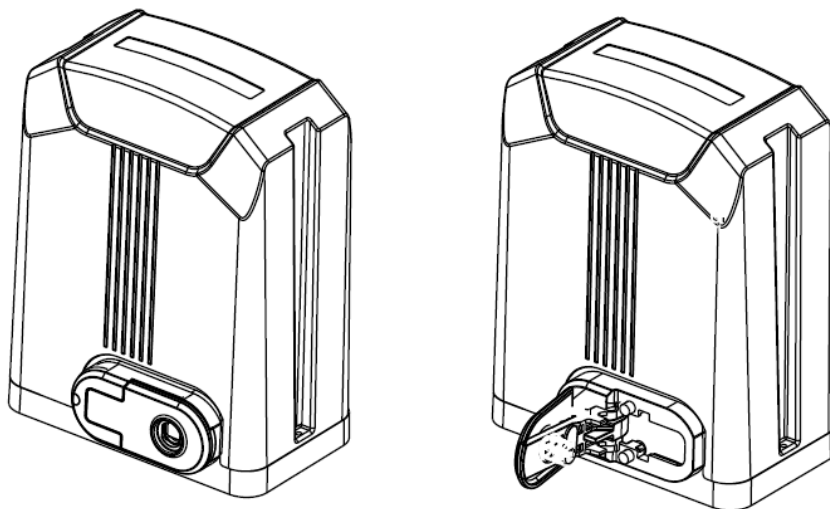

Figure 5

4.3.3 Gear Rack Installation

- Fix the mounting screws to the rack.
- Put the rack on the output gear, make the rack engage with the output gear then weld the mounting screw to the gate (each screw with one solder joints firstly).
- Manually move the gate (gate should be moved smoothly after motor unlocked) to check whether there is a fit clearance between rack and output gear, as shown in Figure 7.
- Weld all the mounting screws to the gate firmly.
- Make sure that all racks on the same straight line.
- Pull the gate after installed, make sure the entire trip is flexible without any stuck.

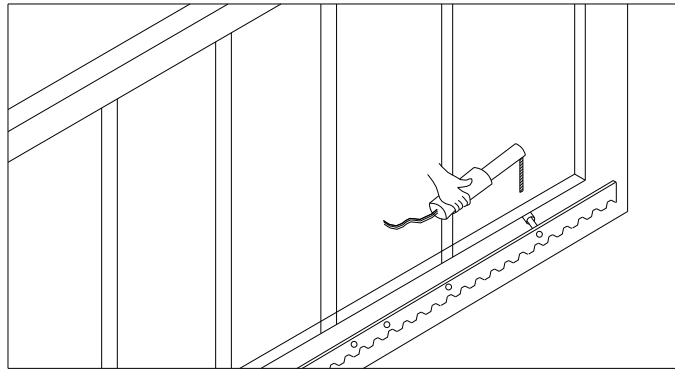

Figure 6

The fit clearance of output gear and rack is shown in Figure 7 below:

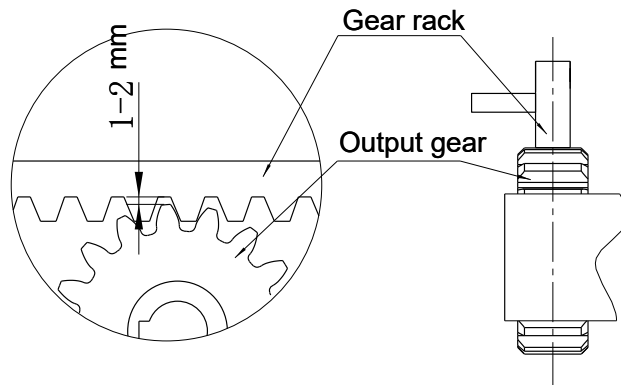

Figure 7



Warnings

- To ensure safety, install safety stop blocks on both ends of the rails to prevent the gate from running out of the rail. Before installing the main machine, make sure that the safety stop blocks are in place and whether it has the function of preventing the gate from running out of the rail or safety range.
- Please make sure that the main machine and its components have good mechanical properties, and the gate can be operated flexibly when manually moved before installing the main machine.

- Please note that for this product, one control can only drive one main machine, otherwise, the control system will be damaged.
- Earth leakage circuit breaker must be installed in where the gate movement can be seen, and the minimum mounting height is 1.5m to avoid being touched by children.
- After installation, please check whether the mechanical property is good or not, whether gate movement after manual unlocking is flexible or not, whether the installation for infrared sensor (optional) is correct and effective.

4.3.4 Limit Switch Adjustment

Magnetic limit switch - The installation position of magnetic limit switch is shown in Figure 8:

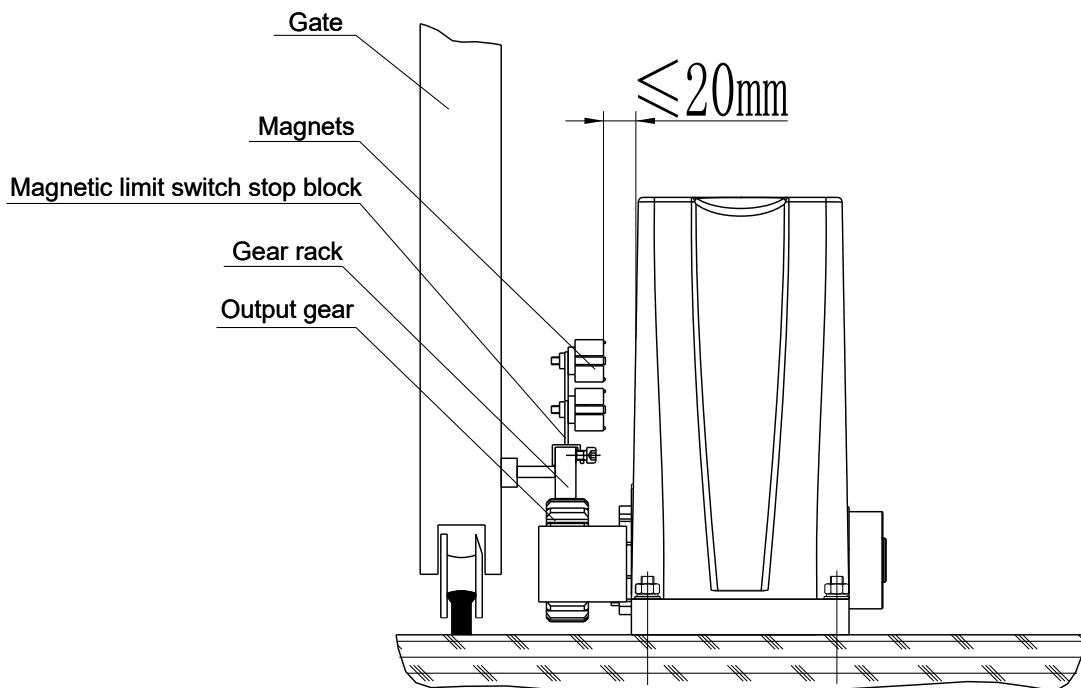

Figure 8

The installation of magnetic limit switch stop block is shown in Figure 9:

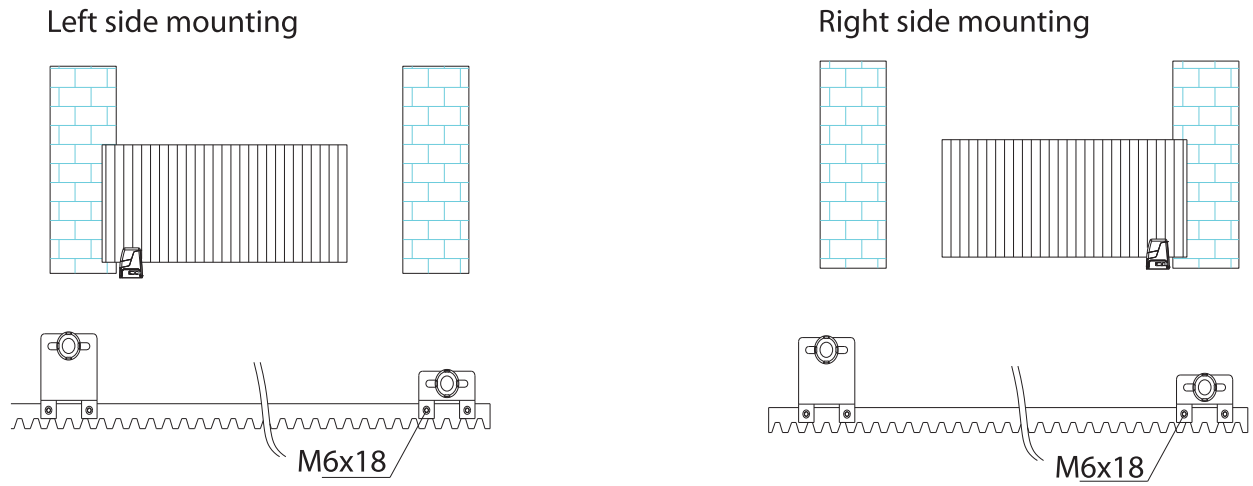

Figure 9

Note: The default setting is right side mounting. (According to actual installation, please refer to the “Note” of section 5.9 to adjust.)

5 Control Board Programming

5.1 Wiring Instruction

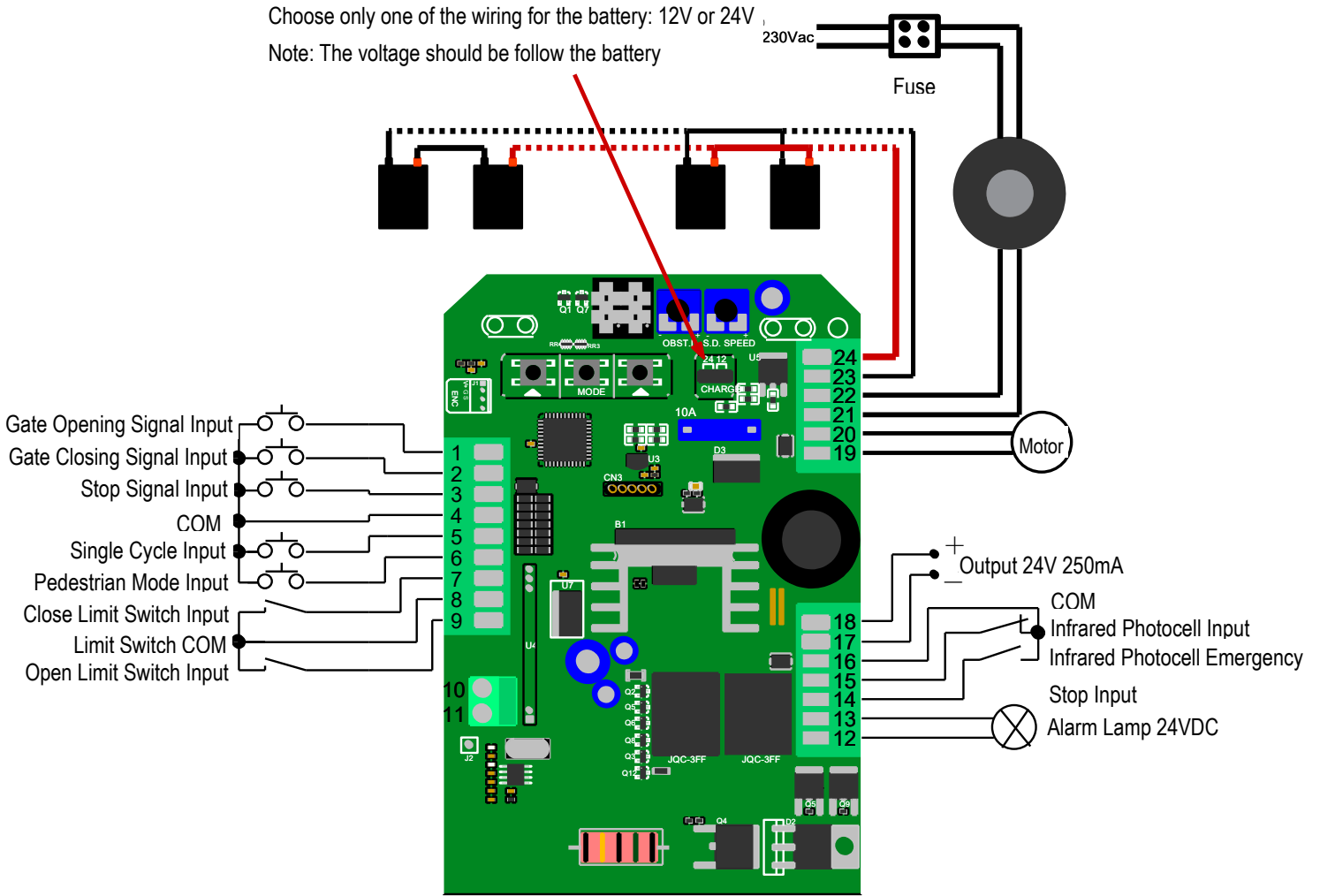

Figure 10

Terminal Instruction:

Terminal	Function Description
1. Gate Opening	For external push button
2. Gate Closing	For external push button
3. Gate Stop	For external push button
4. COM	For external push button
5. Single Cycle Input	For external push button
6. Pedestrian Mode	Gate will open 1m when this function is activated
7. Close Limit Switch	
8. Limit Switch COM	
9. Open Limit Switch	
10. Antenna	
11. Antenna Ground	
12、13. Alarm Lamp Terminal	24VDC
14. Infrared Photocell Emergency Stop	If the emergency stop is activated during the gate waiting for it's automatically close period, it will keep waiting;









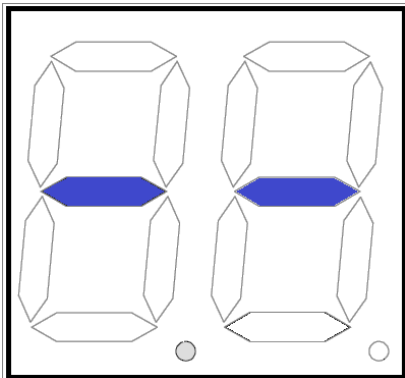

	If activated during gate closing, it'll change to open; If activated during gate opening, it'll stop running and waiting for activation invalid then change to close.
15. Infrared Photocell Input	If the emergency stop is activated during the gate waiting for it's automatically close period, it will keep waiting; If activated during gate closing, it'll change to open;
16. Infrared Photocell COM	
17. 24VDC Negative	Terminal for connecting with external accessories, maximum current on this terminal is 250mA
18. 24VDC Positive	
19、 20. Motor	24V DC motor
21、 22. Transformer Input 24VAC	
23. Battery Negative	The battery should be 24VDC by default.
24. Battery Positive	

5.2 Digital Display Instruction

The digital display on the control board will indicate the current input status. If there is no input, the screen will

display 



	Stop Terminal Input
	Infrared Photocell Emergency Stop Input (N.O.)
	Infrared Photocell Input
	Infrared Photocell Emergency Stop Input (N.C.)
	Gate in Opening
	Gate in Closing
	Start
	Pedestrian Mode Activated
	Close Limit Achieved
	Open Limit Achieved

5.3 Potentiometer Adjustment

Potentiometer TR1 for Adjusting the Sensitivity of Meeting Obstacles

This TR1 is for adjusting the sensitivity of meeting obstacles (clockwise to increase, anticlockwise to decrease). This adjustment will be made only after the travel learning is finished. If the installation site

Note: The potentiometer is adjusted to it's maximum, the obstacles detecting function will be disabled.

Potentiometer TR2 for Regulating the Slowdown Speed

This TR2 is for regulating the slowdown speed. Do not set the speed too low (the minimum speed less than 6cm/sec.) to avoid that the gate opener can't operate normally after the gate condition been worse after years usage.

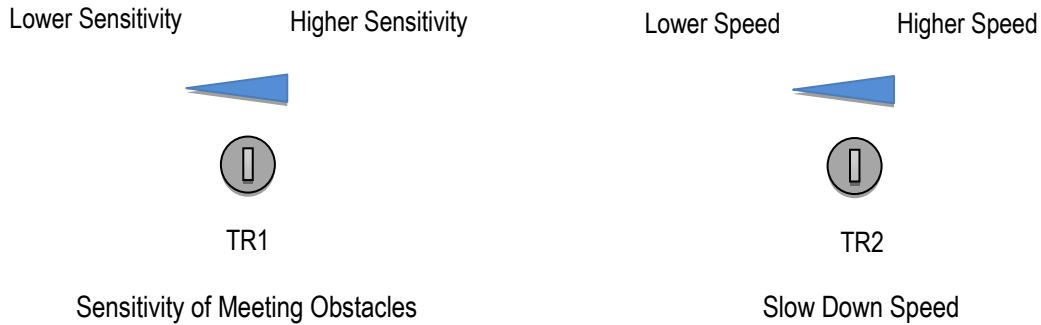

5.4 Quick Travel Setting

Please manually open the gate to the middle position before starting the travel learning. Press and hold \triangle button until

the LED displays  the gate opener will automatically run to it's closed limit position, then will open to it's opened limit position, thereafter, it will close again to it's closed position, after these running, the travel learning is finished.

Note: If you are not sure about the running direction is to open or to close, please close the gate by your hand to it's closed limit position (to fully close the gate) before starting the travel learning, the control board will remember the closed

limit position, and will automatically adjust the running direction (refer to menu  for details)

5.5 Remote Control Pairing

Press ∇ button once, the digital will display , press the button on the remote control, the digital will display

corresponding number such as , remote control pairing is complete.

5.6 Remote Control Deletion

Press and hold ∇ button until the digital displays , all paired remote controls are deleted.

5.7 Remote Control Mode

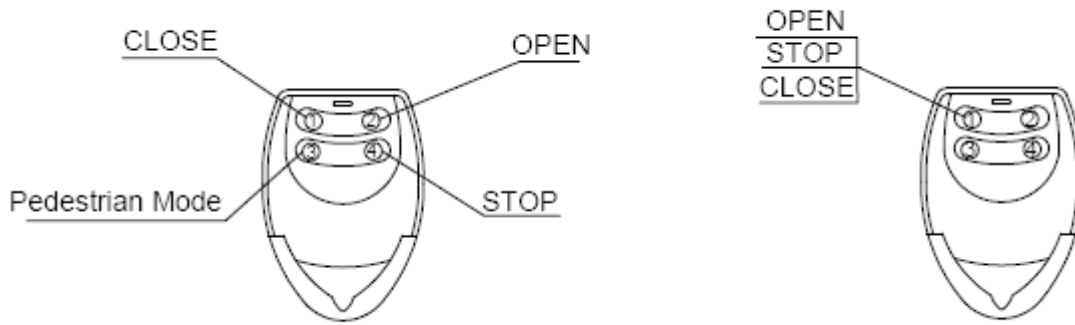

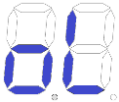



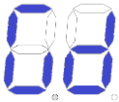



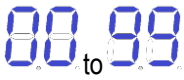

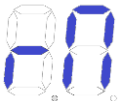





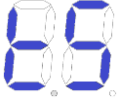
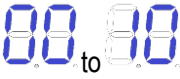









Figure 11

5.8 Function Setting

Press MODE to enter into menu, the digital will display the current selection , press Δ or ∇ to select other options. If need to exit the current menu, you can press  button or press Δ and ∇ buttons at the same time to exit.

If there is no action for 20 seconds, it will exit the current menu automatically.

Menu Press MODE to enter into menu	Selection Press Δ or ∇ to select, press MODE to confirm the selection	Default Status
 Working Mode	 Single cycle Mode  Single cycle mode with Auto-close function  Community mode	 Single cycle mode
 Gate Running Direction	 Open to right  Open to left	 Open to right
 Automatically Close Time		 10 sec.
 Remote Control Mode	 Single channel  Four channels	 Single channel

 Slowdown Speed Time	 88 to 88	 03 3 sec.
 Infrared Photocell Emergency Stop Setting	 88 N.C.  88 N.O.	 88 N.C.
 Limit Switch Setting	 70 N.C.  70 N.O.	 70 N.C.

5.9 Infrared Photocell Connection (optional)

Infrared photocell function: In the closing process, when infrared ray of the photocell is covered by people or objects during its detection range, the gate will open immediately for security protection.

The distance between photocell receiver and photocell emitter should be more than 2 meters, otherwise will affect the induction of the photocell.

If connect the infrared photocell, please remove the jumper wire between terminal 15 and 16.

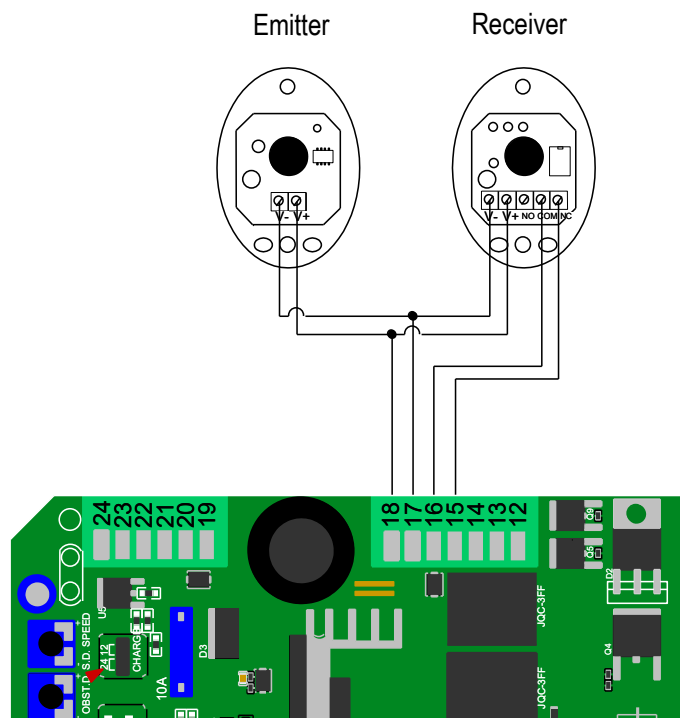

Figure 12

5.10 Solar Power Battery Connection (optional)

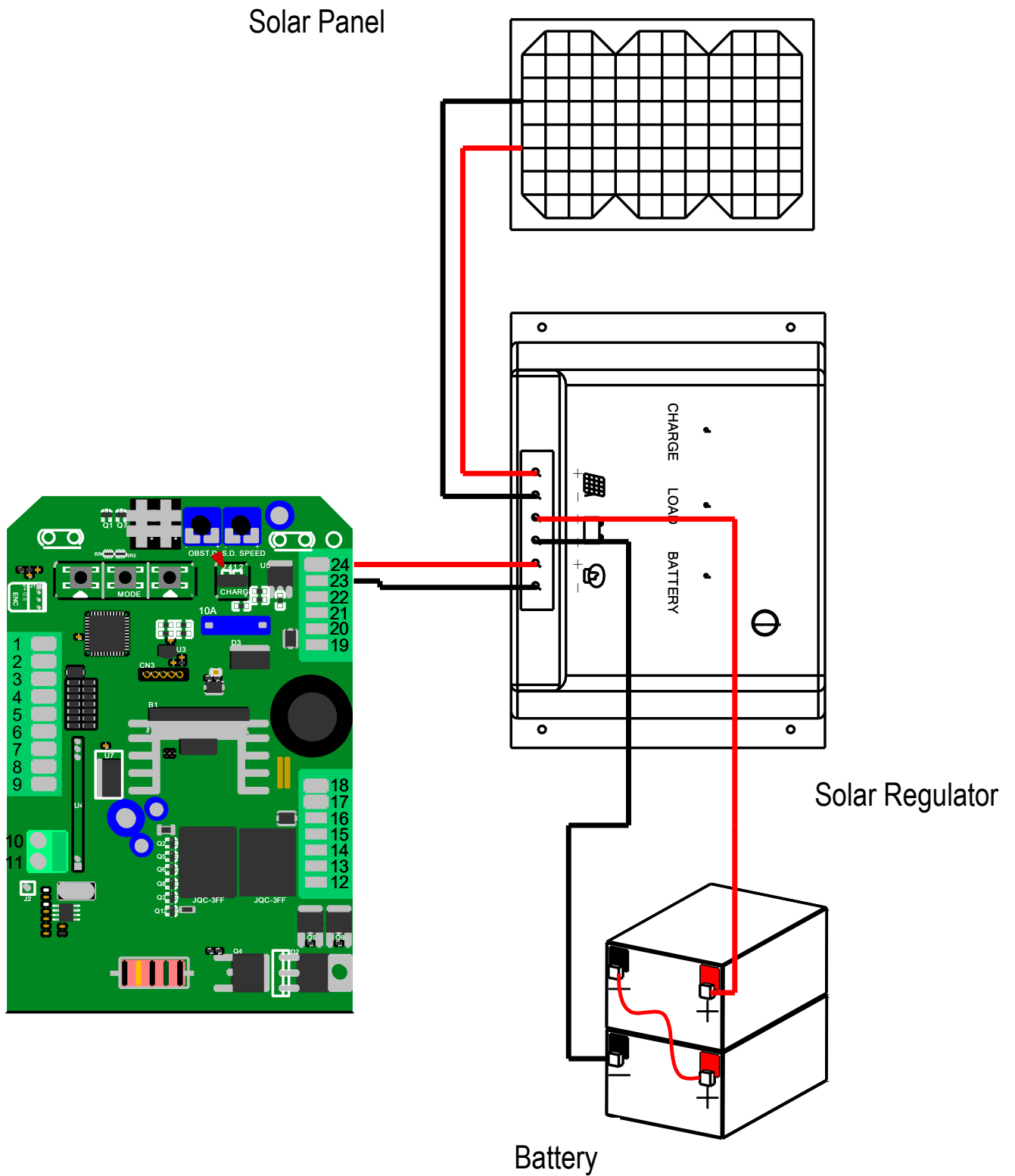

Figure 13

6. Others

6.1 Maintenance

Check whether the gate operates normally every month.

For the sake of safety, each gate is suggested to be equipped with infrared photocell, besides, regular inspection is required.

Before installation and operation of the gate opener, please read all instructions carefully.

Our company reserves the right to change the instruction without prior notice.

6.2 Troubleshooting

Problems	Possible Reasons	Solutions
The gate cannot open or close normally, and LED does not light.	<ol style="list-style-type: none"> 1.The power is off. 2.Fuse is burned. 3.Control board power wiring with problem. 	<ol style="list-style-type: none"> 1.Switch on the power supply. 2.Check the fuse (code F1) and transformer input interface fuse, change the fuse if burnt. 3.Re wiring according to instructions.
The gate can open but cannot close.	<ol style="list-style-type: none"> 1.Photocell wiring with problem. 2.Photocell mounting with problem. 3.Photocell is blocked by objects. 4.Auto-reverse force is too small. 	<ol style="list-style-type: none"> 1.If not connect photocell, please make sure that the infrared port and GND short circuit; if connect infrared sensor, please make sure the wiring is correct and the photocell is N.C. 2.Make sure that the photocell mounting position can be mutually aligned. 3.Remove the obstacle. 4.Increase auto-reverse force.
Remote control doesn't work.	<ol style="list-style-type: none"> 1.Battery level of the remote control is low 2.Remote control learning is not completed 	<ol style="list-style-type: none"> 1.Change the remote control battery 2.Re-conduct remote control learning
Press OPEN, CLOSE button, the gate is not moving, motor has noise.	<ol style="list-style-type: none"> 1.Gate moving is not smoothly. 	<ol style="list-style-type: none"> 1.According to the actual situation to adjust the motor or the gate.
Not stop at the limit position when opening / closing.	<ol style="list-style-type: none"> 1. The limit direction is wrong. 2. The mounting of magnetic limit switch with problem. 	<ol style="list-style-type: none"> 1.Check whether the limit switch wiring is consistent with the actual direction of operation. 2. Check whether the distance between magnetic limit switch and motor, and the height of the magnetic limit switch can meet the mounting requirement.
Leakage switch tripped.	Power supply line short circuit or motor line short circuit.	Check wiring.
Remote control working distance is too short.	Signal is blocked.	Connect with external antenna, should be 1.5 meters above ground.
The gate runs to the middle position then stop or reverse.	<ol style="list-style-type: none"> 1.Auto-reverse force is too small. 2.The sensitivity of meeting obstacle is too small. 3.Gate meets obstacles during closing. 	<ol style="list-style-type: none"> 1.Adjust TR1. 2.Adjust TR2. 3.Remove the obstacle.

Gate opens automatically	Automatic close function was activated but the opening direction was wrongly set.	Please refer to 5.9 to change the opening direction.
--------------------------	---	--

Warranty

Warranty Ordinance

1. To repair against this warranty card and invoice during the warranty period.
2. Warranty period: 1 year after the date of invoice.
3. Without unauthorized dismantling, any product broken or damage due to quality problem, we'll offer the repair service for free or replace for free.
4. The malfunction and damaged caused by incorrect use or man fault is not covered by this warranty.

Maintenance Record

Check Date	Check Content	Maintained by

For Inquiries, Please contact:

Security Shop
Vladimira Popovica 6/6/A606
11070 Novi Beograd, Serbia
Tell: +381 11 318 68 68
office@securityshop.rs

Imported/Distributed by Security Shop doo
license of Blaupunkt
www.blaupunkt.com
Made in China