

HYUNDAI

IP VIDEO INTERCOM SYSTEM HYU-IN-IMO7001

USER MANUAL

IP VIDEO INTERCOM SYSTEM

HYU-IN-IMO7001

7" MONITOR

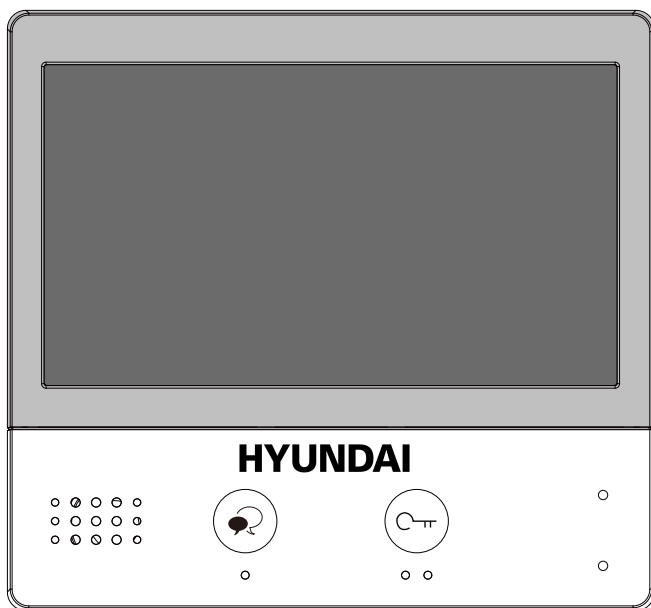

- Please read this manual carefully before using the product you purchase, and keep it well for future use.
- Please note that images and sketch maps in this manual may be different from the actual product.

Contents

1.Parts and Functions	1
2.Mounting	2
3.Main Menu	2
4. Status Bar Icons.....	4
5.Answering a Call	5
6.Monitoring	6
7.Making Calls.....	6
8.View Call Record.....	8
9.No Disturb Mode	9
10.Divert Calls	10
11.Change the Monitor's Settings	10
12.Address Setup.....	13
13.Upgrade	14
14.Specification.....	16
15.Precautions	16

1. Parts and Functions

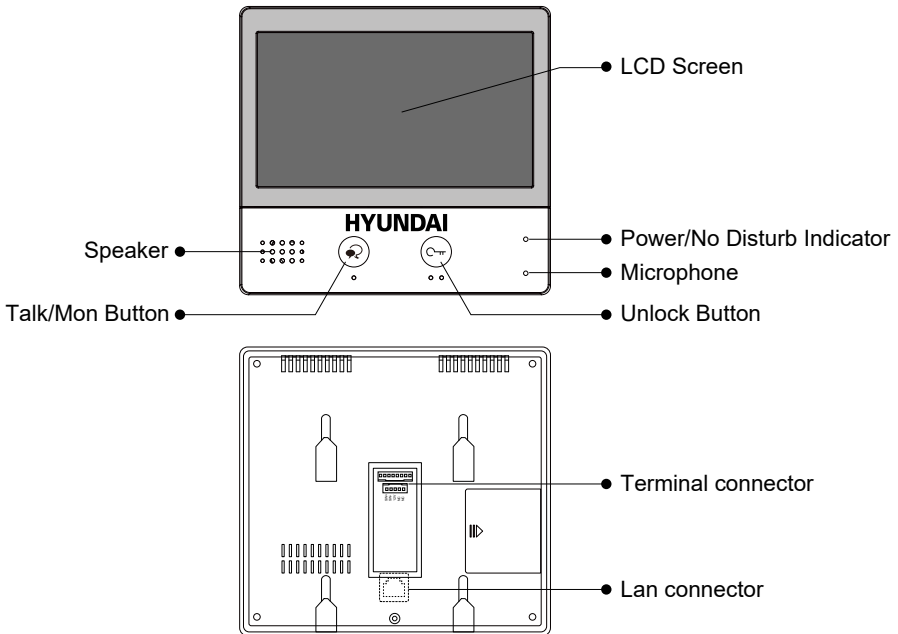

Key functions

Speaker	Send out voice from the visitor.
Talk/Mon button	Press to communicate hands free with visitor; Press to view the outdoor condition in standby mode.
LCD screen	Display the visitors' image.
Power/No Disturb indicator	Show the power status of the system. Show the no disturb status.
Microphone	Transmit audio from one station to other stations.
Unlock button	Press to release the door.
Terminal connector	Use to connect external devices to the indoor station.
Lan connector	Use to connect the indoor station to the network.

2. Mounting

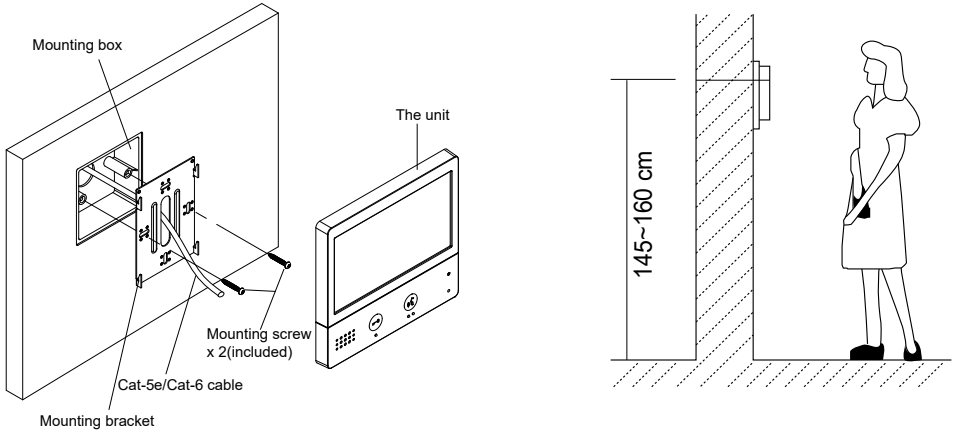

The installation height is suggested to 145~160cm.

1. Use screws to fasten the mounting bracket to the wall with mounting box.
2. Connect the cat-5e or cat-6 cables to the unit.
3. Mount the unit to the mounting bracket, make sure the unit is absolutely attached to the mounting bracket.

3. Main Menu





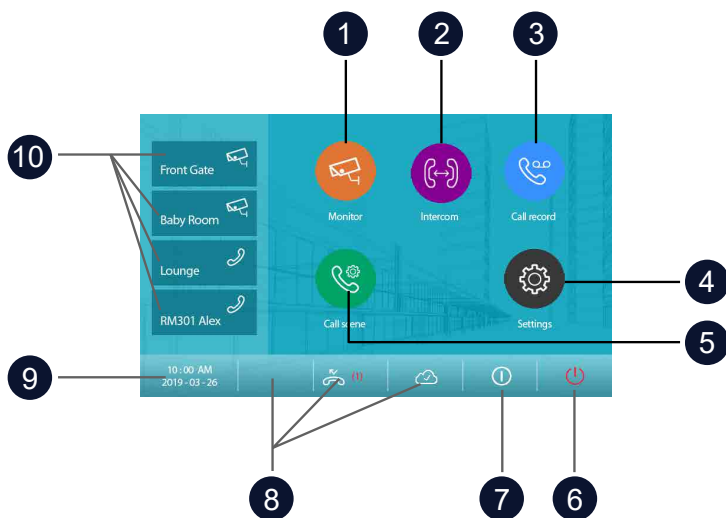



The Main menu is your starting point for using all the applications on your monitor.

Touch **Unlock** button, or touch anywhere of the screen on monitor in standby mode, the Main menu will appear as follow:





- 1 Monitor icon**
Allows you to monitor the door stations, cameras.
- 6 Close icon**
Touch to turn off the screen.
- 2 Intercom icon**
Allows you to call other indoor station.
- 7 About icon**
Allows you to view the information about device.
- 3 Call Record icon**
Allows you to view the call record.
- 8 Status bar**
Displays icons that indicate the indoor station's status(see 4. Status bar icons(page4)).
- 4 Setting icon**
Use to change the indoor station's settings.
- 9 Date and time**
Allows you to set date and time for device.
- 5 Call Scene icon**
Allows you to activate the functions of No disturb, Divert.
- 10 Shortcut windows**
Touch to enter the corresponding items directly.

4. Status Bar Icons



Icon	Description	
	Missed call	Display when there is missed call unread. Touch to review the missed call in shortcut.
	No disturb	Indicates the device is in “No disturb” mode.
	Divert call	Indicates the device is in “Divert call” mode.
	Device online	Indicates device online, but not connect to internet.
	Cloud server worked	Indicates the device is conncteted to the cloud server.
	No cloud server	Indicates the device is not conncteted to the cloud server.
	Cloud server anomaly	Indicates the device cloud server connection is abnormal.
	mute	Indicates the device is in “Mute” mode.

Other status icons



Icon	Description	
	Recording	Indicates the device is recording
	Talking	Indicates the device is in “talking” status.
	Unlock	Indicates open the corresponding door.

5. Answering a Call

When you receive a call, the indoor station rings. Image will be displayed on the screen.

1. Touch  icon or press  **TALK/MON** button.

- Speak within about 50 cm of the microphone.
- Begin communicating hands free with the visitor for 90 seconds.

2. When finished, Touch  icon or press  **TALK/MON** button again.

Available functions while talking on a call

- Door release
- Manual recording

Notes:

1.Receiving a call while talking with a door station

- Other door stations calling is forbidden
- Conclude current talking to answer the new call-in

2.Receiving a call while talking with other monitors

- The talking will stop immediately, call tone sounds in normal.
- The video image from the door station is displayed on the screen, talking,unlock,capture images/videos are available.

6. Monitoring

This section can be used to monitor your home by enabling one of the cameras inside the apartment, the common areas (e.g. garages, garden), and at the entrance.

1. From the main menu, tap **"Monitor"** icon.
2. Select the desired tap.
 - Allows you to select door station camera or IP camera(if the system installs multi door station or IP camera) .
3. Select the desired camera.
4. When finished, tap ← button on panel.

* During monitoring, images can be viewed, but audio cannot be heard.

Available functions during monitoring:

- Door release
- Manual recording

Note: Tap monitor quick actions to monitor corresponding camera directly(If the monitor quick actions is set on the shortcut windows).

7. Making Calls

You can call other residences, common area phones or facility staff office, and even other rooms in your own residence.

whichever monitor answers the call, you can use many of the features described in feature available while talking on a call.

Namelist call by using the namelist

1. From the main menu, tap **"Intercom"** icon.
 - A list of available items is displayed.
2. Select "Namelist".
 - A list of name is displayed if the system allows.
3. Select the desired name.
 - Calling the target directly.

Innercall

If you have monitors installed in different rooms in your residence, you can call those rooms and use the system as an intercom.

1. From the main menu, tap **"Intercom"** icon.
 - A list of available items is displayed.
2. Select "Inner call".
 - A list of M/S is displayed.
3. Select the desired target.
 - Calling the target directly.

Calling guard station

1. From the main menu, tap **"Intercom"** icon.
 - A list of available items is displayed.
2. Select "Guard station".
 - Calling the target directly.

8. View Call Record

The monitor records information about calls you have answered, missed, and made, and saves it in the call record. See the following steps to view the call record.

1. From the main menu, tap **"Call record"** icon.
2. Select the desired tap.
 - Missed: Displays calls you received but did not answer.
 - Incoming: Displays calls you answered.
 - Outgoing: Displays calls you made.
 - Playback: Displays pictures/videos you received / made.
3. Browse the call record as needed.
4. When finished, tap ← , return to previous menu.(or tap  return to home page)





Play pictures/videos

you can record camera images/videos manually while talking to a visitor or monitoring camera images/videos. See the following steps to play the pictures/videos.

1. From the main menu, tap **"Call record"** icon.
2. Select the desired tap.
3. Tap the desired call record.
 - Displays the images/videos
4. When finished, tap ← .

Controlling pictures/videos playback

The following controls are available by tapping the screen while playing a image/video.

-  Plays the image/video.
-  Plays the next image/video.
-  Plays the previous image/video.
-  Delete image/video.
-  Delete confirm.

Limitations

Up to 120 records can be saved, up to 120 images can be saved. Subsequent records/images/videos will overwrite the oldest items.

9. No Disturb Mode

During a certain period, if you don't want to be disturbed, you can go to set DND mode.

1. From the main menu, tap **"Call scene"** icon.
2. Select the desired tap.
 - No disturb 8H: Set to no disturb mode 8 hours.
 - No disturb always: Set to no disturb mode always.

Note:

* The no disturb indicator turns from green to red, to indicate that the no disturb function has been activated.

* This function will perform immediately if selected, and the status bar on main menu interface will show "" icon.

10. Divert Calls

The calling from door station can be diverted to your smart phone. please note that this function should be supported by SIP network.

1. From the main menu, tap **"Call scene"** icon.
2. Select the desired tap.
 - Divert call if no answer: If nobody answers the call in 30s when receives call from door station, diverts the call to the smart phone. At this mode, the monitor will always open the screen and show image from door station during diverted, if the monitor answers the call at this time, diverted will conclude at once.
 - Divert call always: When receives call from door station, diverts the call to smart phone directly. At this mode, the monitor will shut off the screen after diverting successfully, but you can still use it in normal.





Note:

- * If divert the call to smart phone via Sip sever, need to choose one.
- * This function will perform immediately if selected, and the status bar on main menu interface will show "📞" icon.

11. Change the Monitor's Settings

1. From the main menu, tap **"Setting"** icon.
 - A list of available setting categories is displayed.
2. Select the desired tap.
3. Select the desired setting category.
4. Change the settings as desired.
5. Tap ← / 🏠 to save the new setting.

List of settings

 Call Tune >	Ring volume - Ring timing - DS ring - CDS ring - OS ring - Message ring - Doorbell ring - Intercom ring - Innercall ring - Alarm ring
 General >	Date and time - Language - Monitor timing - Shortcut setting - SD card
 Installer >	IP address - Call_Nbr - Parameter - Upgrade - Onsite tools
 Manager >	Sipconfig - Private unlock code - Common unlock code - Card manager - Back and restore
 Ext.Unit >	Auto setup wizard - IM extensions - Outdoor Stations - IPC camera - Enter OS binding

Example: "DS ring"setting

1. From the main menu, tap "**Setting**" icon.
 - A list of available setting categories is displayed.
2. Select "Call Tune", and then tap "DS ring" item.
 - A list of available tune is displayed.
3. Select the tune as desired, and tap.
4. Tap ← / 🏠 to save the new setting.

Ring volume: adjust the ringtone volume.

Ring timing: adjust the ringtone time.

DS ring: call tone from door entrance panel.

CDS ring: call tone from common door entrance panel.

OS ring: call tone from out door entrance panel.

Message ring: call tone when received message.

DoorBell ring: call tone from doorbell.

Intercom ring: call tone from an intercom of another apartment.

InnerCall ring: call tone from an intercom in your apartment.

Alarm ring: call tone when alarm.

Example: "Date and time"setting

1. From the main menu, tap "**Setting**" icon.
 - A list of available setting categories is displayed.
2. Select "General", and then tap "Date and time" item.
 - Date and time setting interface is displayed.
3. Select and change the settings as desired.
4. Tap ← / 🏠 to save the new setting.

Date mode: 2 display mode: month/date/year and date/month/year

Time mode: 2 display mode: HOUR_12 and HOUR_24.

Date: touch it to set the date .

Time: touch it to set the time.

Internet time: touch it can synchronize the system time.

Example: "Language"setting

1. From the main menu, tap "**Setting**" icon.
 - A list of available setting categories is displayed.
2. Select "General", and then tap "Language" item.
 - Language interface is displayed.
3. Select and change the settings as desired.
4. Tap ← / 🏠 to save the new setting.

Example: "Shortcut setting"

1. From the main menu, tap "**Setting**" icon.
 - A list of available setting categories is displayed.
2. Select "General", and then tap "Shortcut setting" item.
 - Shortcut setting interface is displayed.
3. Select the type of function for which you want to add/remove a quick action.
4. Tap ← / 🏠 to save the new setting.

Note: Other settings are related to the system type. Please make settings according to the functions provided by your system.

12. Address Setup

1. From the main menu, tap "**Setting**" icon.
 - A list of available setting categories is displayed.
2. Select "Installer", and then tap "Call_Nbr" item.
3. Input password if required (66666666 by default).

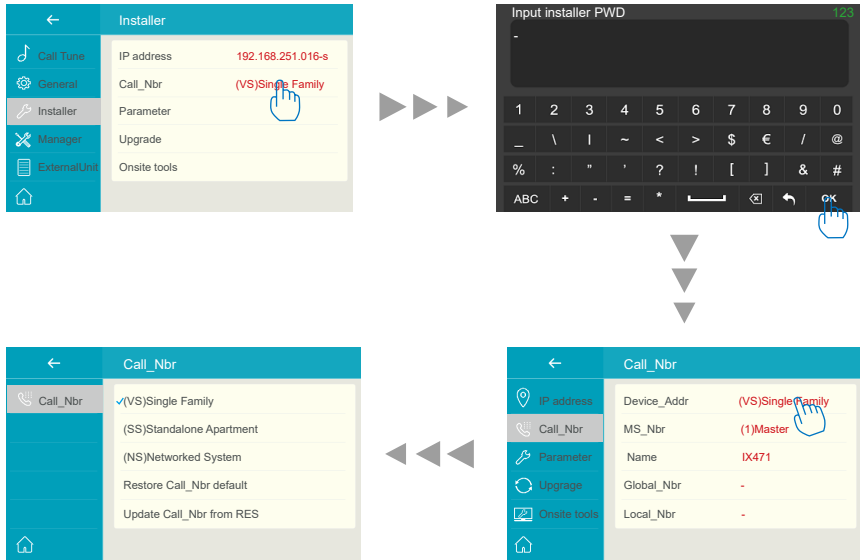

Device_Addr:

"(VS)Single Family": For villa single one-to-one installation, no need to input room number.

"(SS)Standalone Apartment": for standalone building, tap to input room number (1-digit, 2-digit, 3-digit, 4 digit as you defined).

Ex: Tap "(SS)" and input 0001 for room standalone building.

"(NS)Networked System": for standalone building, input 8digits number(must 8-digit input), first 4digits for building/block number, last 4digits for room number.

EX: 00010003 1st building 3rd monitor; 00030005 3rd building 5th monitor

"Restore/Update from RES": Reserve for configurations database file (RES file) update and backup.

MS_NBR:

Master and slave number, 01 is master monitor, 02~32 is slave monitor.

Name:

The "Name" input here will sync to door station's calling list automatically.

Global_Nbr:

Extra call number for common door station calling to this monitor.

Local_Nbr:

Extra call number for door station in same building calling to this monitor

13. Upgrade

1. From the main menu, tap **"Setting"** icon.
 - A list of available setting categories is displayed.
2. Select "Installer", and then tap "Upgrade" item.
3. Input installer password (66666666 by default, or password free when door station into installer mode and enable it)

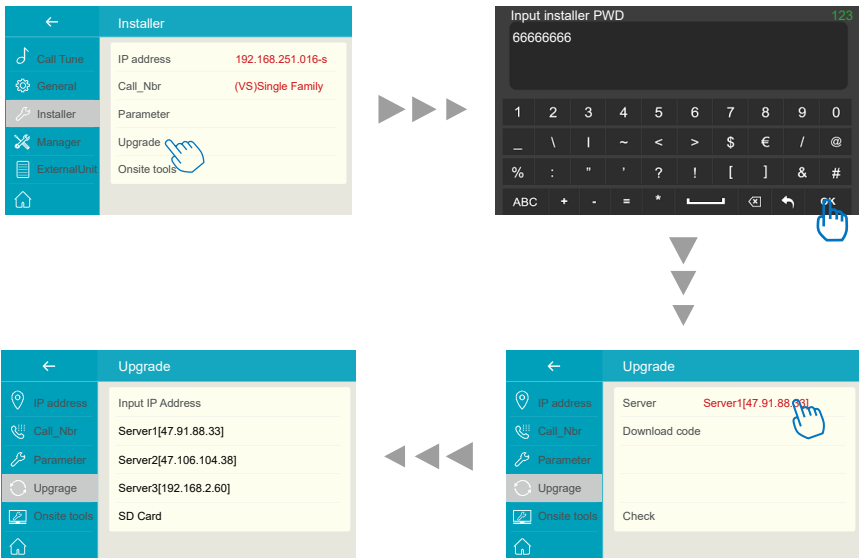

Tap “Server” to select firmware source, update firmware could come from as below, tap on the source:

1. **Cloud Server**

Cloud server requires internet.

Server1[47.91.88.33]

Server2[47.106.104.38]

2. **Local LAN server (IX -Builder)**

Use IX-Builder PC software to create a temporary local server for update.

Server3[192.168.2.60] #IX-Builder default IP

[Input IP address]

3. **SD card**

Copy upgrade firmware before upgrade.

SD card

After tap “Download code” and input code, the code could get from v-tec support team when device needed to update. After all, tap “Check” to load upgrade information from source.

With tips on the screen as below:

Please insert SD card. #Some upgrade is oversized, require SD card to store firmware.

Mismatched. #Update firmware was founded, but is not suitable for this device.

Connect Error. #Check networks.

No file. #Source has been inspected but there is no firmware need to upgrade.

Otherwise the device will go into upgrade automatically, please do not power off during upgrade.

14. Specification

- Power Source: Power-over-Ethernet (IEEE 802.3af Class 0)
- LAN Interface: 10 BASE-T / 100 BASE-TX Ethernet (RJ-45)
- Monitor screen: 7 Inch digital color TFT
- Display Resolutions: 800*480 resolution
- Wire Type: Cat-5e or Cat-6
- Wiring Distance: 100m (Approx. 330')
- Operating temperature: -10 to +50 (oC)
- Dimension: 161(H)×174(W)×22(D)mm

15. Precautions

- 1) All components should be protected from violence vibration. And not allow to be impacted, knocked and dropped.
- 2) Please do the cleanness with soft cotton cloth, please do not use the organic impregnant or chemical clean agent. If necessary, please use a little pure water or dilute soap water to clean the dust.
- 3) Image distortion may occur if the video monitor is mounted too close to magnetic field e. g. Microwaves, TV, computer etc.
- 4) Please keep away the monitor from wet, high temperature, dust, caustic and oxidation gas in order to avoid any unpredictable damage.
- 5) Must use the right adaptor which is supplied by the manufacturer or approved by the manufacturer.
- 6) Pay attention to the high voltage inside the products, please refer service only to a trained and qualified professional.

HYUNDAI

For Inquiries, Please Contact:

Security Shop
Vladimira Popovica 6/6/A606
11070 Novi Beograd, Serbia
Tell +381 11 318 68 68
office@securityshop.rs

Imported/Distributed by Security Shop Doo
Licensed by Hyundai Corporation Holdings, Korea
Delivery and After Service shall only be covered within Serbia